

(Provisional)

**MYANMAR**

**NATIONAL**

**BUILDING**

**CODE**

**2012**

**PART 5B**

**BUILDING SERVICES**

**( ELECTRICAL AND ALLIED INSTALLATIONS )**

## TABLE OF CONTENTS

NO.	TITLE	PAGE
5B.1	SCOPE	... 4
5B.2	TERMINOLOGY AND CONVENTIONAL SYMBOLS	... 4
5B.3	GENERAL REQUIREMENTS	... 10
5B.4	PLANNING OF ELECTRICAL INSTALLATIONS	... 11
5B.5	DISTRIBUTION OF SUPPLY AND CABLING	... 20
5B.6	WIRING	... 40
5B.7	FITTINGS AND ACCESSORIES	... 53
5B.8	EARTHING	... 59
5B.9	INSPECTION AND TESTING OF INSTALLATION	... 64
5B.10	TELECOMMUNICATION AND OTHER MISCELLANEOUS SERVICES	... 73
5B.11	LIGHTNING PROTECTION OF BUILDINGS	... 76
ANNEX A	DRAWING SYMBOLS FOR ELECTRICAL INSTALLATION IN BUILDING	... 85
ANNEX B	AREA REQUIRED FOR TRANSFORMER ROOM AND SUBSTATION FOR DIFFERENT CAPACITIES	... 89
ANNEX C	ADDITIONAL AREA REQUIRED FOR GENERATOR IN ELECTRIC SUBSTATION	... 90
ANNEX D	FORM OF COMPLETION CERTIFICATE	... 91
	LIST OF STANDARDS	... 93

**MYANMAR NATIONAL BUILDING CODE**

**PART 5B BUILDING SERVICES**

**Electrical and Allied Installations**

**5B.1 SCOPE**

This Section covers the essential requirements for electrical installations in buildings to ensure efficient use of electricity including safety from fire and shock. This Section also includes general requirements relating to lightning protection of buildings and lighting.

**5B.2.0 TERMINOLOGY AND SYMBOLS**

**5B.2.1** For the purpose of this Section, the following definitions shall apply.

**5B.2.1.1** *Accessory* — A device, other than current using equipment, associated with such equipment or with the wiring on an installation.

**5B.2.1.2** *Apparatus* — Electrical apparatus including all machines, appliances and fittings in which conductors are used or of which they form a part.

**5B.2.1.3** *Appliance* — An item of current using equipment other than a luminaire or an independent motor.

**5B.2.1.4** *Bunched* — Cables are said to be 'bunched' when two or more are contained within a single conduit, duct, ducting, or trunking or, if not enclosed, are not separated from each other.

**5B.2.1.5** *Cable* — A length of single-insulated conductor (solid or stranded), or two or more such conductors, each provided with its own insulation, which are laid up together. The insulated conductor or conductors may or may not be provided with an overall mechanical protective covering.

**5B.2.1.6** *Cable, Armoured* — A cable provided with a wrapping of metal (usually in the form of tape or wire) serving as a mechanical protection.

**5B.2.1.7** *Cable, Flexible* — A cable containing one or more cores, each formed of a group of wires, the diameters of the cores and of the wires being sufficiently small to afford flexibility.

**5B.2.1.8** *Cable, Metal-Sheathed* - An insulated cable with a metal sheath.

**5B.2.1.9** *Cable, PVC Sheathed-Insulated* — A cable in which the insulation of the conductor is a polyvinylchloride (PVC) compound; with PVC sheath also providing mechanical protection to the conductor core or cores in the cable.

**5B.2.1.10** *Cable, Weatherproof* — A cable so constructed that when installed in uncovered locations, it will withstand all kinds of weather variations (*see 5B.2.1.80*, for definition of Weatherproofing).

**5B.2.1.11** *Cable, XLPE* — A cable in which the insulation of the conductor is cross-linked polythene and the mechanical protection is provided for the core or cores by a sheath of a poly vinyl chloride compound.

**5B.2.1.12 Ceiling Rose** — A fitting (usually used to attach to the ceiling) designed for the connection between the electrical installation wiring and a flexible cord (which is in turn connected to a lampholder).

**5B.2.1.13 Circuit** — An assembly of electrical equipment supplied from the same origin and protected against overcurrent by the same protective device(s). Certain types of circuit are categorized as follows:

- a) *Category 1 Circuit* — A circuit (other than a fire alarm or emergency lighting circuit) operating at low voltage and supplied directly from a mains supply system.
- b) *Category 2 Circuit* — With the exception of fire alarm and emergency lighting circuits, any circuit for telecommunication (for example, radio, telephone, sound distribution, intruder alarm, bell and call and data transmission circuits) which is supplied from a safety source.

*Category 3 Circuit* — A fire alarm circuit or an emergency lighting circuit.

**5B.2.1.14 Circuit Breaker** — A mechanical switching device capable of making, carrying and breaking currents under normal circuit conditions and also of making, carrying for a specified time, and breaking currents under specified abnormal circuit conditions such as those of short circuit.

NOTE — A circuit breaker is usually intended to operate infrequently, although some types are suitable for frequent operation.

**5B.2.1.15 Circuit, Final Sub** — An outgoing circuit connected to one-way distribution board and intended to supply electrical energy at one or more points to current, using appliances without the intervention of a further distribution board other than a one-way board. It includes all branches and extensions derived from that particular way in the board.

**5B.2.1.16 Cleat** — An insulated incombustible support normally used for insulated cable.

**5B.2.1.17 Conductor, Aerial** — Any conductor which is supported by insulators above the ground and is directly exposed to the weather.

NOTE — Four classes of aerial conductors are recognized:

- a) Bare aerial conductors,
- b) Covered aerial conductors,
- c) Insulated aerial conductors, and
- d) Weatherproof neutral-screened cable.

**5B.2.1.18 Conductor, Bare** — A conductor not covered with insulating material.

**5B.2.1.19 Conductor, Earthed** — A conductor with no provision for its insulation from earth.

**5B.2.1.20 Conductor, Insulated** — A conductor adequately covered with insulating material of such quality and thickness as to prevent danger.

**5B.2.1.21 Conductor of a Cable or Core** — The conducting portion consisting of a single wire or group of wires, assembled together and in contact with each other or connected in parallel.

**5B.2.1.22 Connector** — The part of a cable coupler or of an appliance coupler which is provided with female contact and is intended to be attached to the flexible cable connected to the supply.

**5B.2.1.23 Connector Box or Joint Box** — A box forming a part of wiring installation, provided to contain joints in the conductors of cables of the installations.

**5B.2.1.24 Connector for Portable Appliances** — A combination of a plug and socket arranged for attachment to a portable electrical appliance or to a flexible cord.

**5B.2.1.25 Consumer's Terminals** — The ends of the electrical conductors situated upon any consumer's premises and belonging to him at which the supply of energy is delivered from the service line.

**5B.2.1.26 Cord, Flexible** — A flexible cable having conductor of small cross-sectional area. Two flexible cords twisted together are known as twin 'flexible cord'.

**5B.2.1.27 Core of a Cable** — A single conductor of a cable with its insulation but not including any mechanical protective covering.

**5B.2.1.28 Cut-out** — Any appliance for automatically interrupting the transmission of energy through any conductor when the current rises above a predetermined amount.

**5B.2.1.29 Damp Situation** — A situation in which moisture is either permanently present or intermittently present to such an extent as to be likely to impair the effectiveness of an installation conforming to the requirements for ordinary situations.

**5B.2.1.30 Dead** — A portion of the circuit (normally expected to carry a voltage) at or near about earth potential or apparently disconnected from any live system.

**5B.2.1.31 Direct Earthing System** — A system of earthing in which the parts of an installation are so earthed as specified but are not connected within the installation to the neutral conductor of the supply system or to earth through the trip coil of an earth leakage circuit-breaker.

**5B.2.1.32 Distance Area or Resistance Area (for Earth Electrode only)** — The area of ground (around an earth electrode) within which a voltage gradient measurable with ordinary commercial instruments exists when the electrode is being tested.

**5B.2.1.33 Discrimination (Over-Current Discrimination)** — Co-ordination of the operating characteristics of two or more over-current protective devices such that, on the incidence of over-currents within stated limits, the device intended to operate within these limits does so, while the others do not.

#### NOTES

- 1) Protective devices should have discrimination so that only the affected part (minimum section) of the circuit is isolated, even though a number of protective devices may be in the path of the over current.
- 2) Distinction is made between series discrimination involving different over-current protective devices passing substantially the same over-current and network discrimination involving identical protective devices passing different proportions of the over-current.

**5B.2.1.34 Earth** — The conductive mass of the earth, whose electric potential at any point is conventionally taken as zero.

**5B.2.1.35 Earth Continuity Conductor** — The conductor, including any clamp, connecting to the earthing lead or to each other those parts of an installation which are required to be

## ELECTRICAL AND ALLIED INSTALLATIONS

earthed. It may be in whole or in part the metal conduit or the metal sheath or armour of the cables, or the special continuity conductor of a cable or flexible cord incorporating such a conductor.

**5B.2.1.36 Earth Electrode** — A conductor or group of conductors in intimate contact with and providing an electrical connection to earth.

**5B.2.1.37 Earth Fault** — Accidental connections of a conductor to earth when the impedance is negligible, the connection is called a dead earth.

**5B.2.1.38 Earthing Lead** — The final conductor by which the connection to the earth electrode is made.

**5B.2.1.39 Earth Leakage Circuit Breaker System** — A system of earthing in which the parts of an installation, specified, to be earthed are so earthed through one or more earth leakage circuit-breakers or relays.

**5B.2.1.40 Enclosed Distribution Board** — An enclosure containing bus bars with one or more control and protected devices for the purpose of protecting, controlling or connecting more than one outgoing circuits fed from one or more incoming circuits.

**5B.2.1.41 Exposed Metal** — All metal parts of an installation which are easily accessible other than:

- a) parts separated from live parts by double insulation;
- b) metal name-plates, screw heads, covers, or plates, which are supported on or attached or
  - i. connected to substantial non-conducting material only in such a manner that they do not
  - ii. become alive in the event of failure of insulation of live parts and whose means of fixing
  - iii. do not come in contact with any internal metal; and
- c) parts which are separated from live parts by other metal parts which are themselves
  - i. earthed or have double insulation.

**5B.2.1.42 Fire Survival Cable** — A cable which continues in service after exposure to a temperature of 900°C for 20 min or 700°C for 90 min.

**5B.2.1.43 Fitting, Lighting** — A device for supporting or containing a lamp or lamps (for example, fluorescent or incandescent) together with any holder, shade, or reflector, for example, a bracket, a pendant with ceiling rose, an electrolier, or a portable unit.

**5B.2.1.44 Flameproof Enclosure** — An enclosure which will withstand without injury any explosion of inflammable gas that may occur within it under practical conditions of operation within the rating of the apparatus (and recognized overloads, if any, associated therewith) and will prevent the transmission of flame which may ignite any inflammable gas that may be present in the surrounding atmosphere.

### NOTES

- 1) Hazardous areas are classified into different zones, depending upon the extent to which an explosive atmosphere could exist at that place. In such areas flame proof switchgear, fittings, accessories, have to be used/installed in flameproof enclosure.

- 2) An electrical apparatus is not considered as flameproof unless it complies with the appropriate statutory regulations.
- 3) Other types of fittings are also in vogue in wiring installations, for example, 'increased safety'.

**5B.2.1.45** *Flame Retardant Cable* — Flame retardant cable with reduced halogen evaluation and smoke.

**5B.2.1.46** *Fuse* — A device that, by the fusion of one or more of its specially designed and proportioned components, opens the circuit in which it is inserted when the current through it exceeds a given value for a sufficient time. The fuse comprises all the parts that form the complete device.

**5B.2.1.47** *Fuse-Element* — A part of the fuse-link designed to melt under the action of current exceeding some definite value for a definite period of time.

**5B.2.1.48** *Harmonics (Current and Voltage)* — All alternating current which is not absolutely sinusoidal is made up of a fundamental and a certain number of current harmonics which are the cause of its deformation (distortion) when compared to the theoretical sine-wave.

**5B.2.1.49** *Inflammable* — A material capable of being easily ignited.

**5B.2.1.50** *Installation (Electrical), of Buildings* — An assembly of associated electrical equipment to fulfil a specific purpose or purposes and having coordinated characteristics.

**5B.2.1.51** *Insulated* — Insulated shall mean separated from adjacent conducting material or protected from personal contact by a non-conducting substance or an air space, in either case offering permanently sufficient resistance to the passage of current or to disruptive discharges through or over the surface of the substance or space, to obviate danger or shock or injurious leakage of current.

**5B.2.1.52** *Insulation, Basic* — Insulation applied to live parts to provide basic protection against electric shock.

NOTE— Basic insulation does not necessarily include insulation used exclusively for functional purposes.

**5B.2.1.53** *Insulation, Double* — Insulation comprising both basic and supplementary insulation.

**5B.2.1.54** *Insulation (Electrical)* — Suitable non-conducting material, enclosing, surrounding or supporting a conductor.

**5B.2.1.55** *Insulation, Reinforced* — Single insulation applied to live parts, which provides a degree of protection against electric shock equivalent to double insulation under the conditions specified in the relevant standard.

NOTE — The term 'single insulation' does not imply that the insulation must be one homogeneous piece. It may comprise several layers which cannot be tested singly as supplementary or basic insulation.

**5B.2.1.56** *Insulation, Supplementary* — Independent insulation applied in addition to basic insulation in order to provide protection against electric shock in the event of a failure of basic insulation.

## ELECTRICAL AND ALLIED INSTALLATIONS

**5B.2.1.57** *Linked Switch* — Switches linked together mechanically so as to operate simultaneously or in definite sequence.

**5B.2.1.58** *Live or Alive* — Electrically charged so as to have a potential different from that of earth.

**5B.2.1.59** *Locations, Industrial* — Locations where tools and machinery requiring electrical wiring are installed for manufacture or repair.

**5B.2.1.60** *Locations, Non-Industrial* — Locations other than industrial locations, and shall include residences, offices, shops, showrooms, stores and similar premises requiring electrical wiring for lighting, or similar purposes.

**5B.2.1.61** *Miniature Circuit Breaker* — Mechanical switching device capable of making, carrying and breaking currents under normal circuit conditions and also making carrying currents for specified times and automatically breaking currents under specified abnormal circuit conditions such as those of overload and short circuits.

**5B.2.1.62** *Multiple Earthed Neutral System* — A system of earthing in which the parts of an installation specified to be earthed are connected to the general mass of earth and, in addition, are connected within the installation to the neutral conductor of the supply system.

**5B.2.1.63** *Neutral Conductor* — Includes the neutral conductor of a three-phase four-wire system, the conductor of a single-phase or dc installation which is earthed by the supply undertaking (or otherwise at the source of the supply), and the middle wire or common return conductor of a three-wire dc or single-phase ac system.

**5B.2.1.64** *Plug* — A device, provided with contact pins, which is intended to be attached to a Flexible cable, and which can be engaged with a socket outlet or with a connector.

**5B.2.1.65** *Point (in Wiring)* — A termination of the fixed wiring intended for the connection of current using equipment.

**5B.2.1.66** *Residual Current Circuit Breaker* — A mechanical switching device design to make, carry and break currents under normal service conditions and to cause the opening of the contacts when the residual currents attains a giving value under specified conditions.

**5B.2.1.67** *Service* — The conductor sand equipment required for delivering energy from the electric supply system to the wiring system of the premises served.

**5B.2.1.68** *Socket-Outlet* — Accessory having socket contacts designed to engage with the pins of a plug and having terminals for the connection of cable(s).

NOTE — A luminaire track system is not regarded as a socket- outlet system.

**5B.2.1.69** *Switch* — A mechanical switching device capable of making, carrying and breaking current under normal circuit conditions, which may include specified operating overload conditions, and also of carrying for a specified time currents under specified abnormal circuit conditions such as those of short circuit.

NOTE—A switch may also be capable of making, but not breaking, short-circuit currents.

**5B.2.1.70** *Switchboard* — An assembly of switchgear with or without instruments, but the term does not apply to a group of local switches in a final circuit.

NOTE — The term 'switchboard' includes a distribution board.

**5B.2.1.71** *Switch Disconnectors* — A device used to open (or close) a circuit when either negligible current is interrupted (or established) or when the significant change in the voltage



across the terminals of each of the pole of the disconnectors occurs; in the open position it provides an isolating distance between the terminals of each pole.

**5B.2.1.72** *Switch Disconnector Fuse* — A composite unit, comprising a switch with the fuse contained in or mounted on the moving member of the switch.

**5B.2.1.73** *Switchgear* — A general term covering switching devices and their combination with associated control, measuring, protective and regulating equipment, also assemblies of such devices and equipment with associated interconnections, accessories, enclosures and supporting structures, intended in principle for use in connection with generation, transmission, distribution and conversion of electric energy.

**5B.2.1.74** *Usable Wall Space* — All portions of a wall, except that occupied by a door in its normal open position, or occupied by a fire place opening, but excluding wall spaces which are less than 1 m in extent measured along the wall at the floor line.

**5B.2.1.75** *Voltage, Extra Low (ELV)* — The voltage which does not normally exceed 50 V.

**5B.2.1.76** *Voltage, Low (LV)* — The voltage which normally exceed 50 V but does not normally exceed 250 V.

**5B.2.1.77** *Voltage, Medium (MV)* — The voltage which normally exceeds 250 V but does not exceed 650 V.

**5B.2.1.78** *Voltage, High (HT, HV)* — The voltage which normally exceeds 650 V but less than or equal to 33 kV.

**5B.2.1.79** *Voltage, Extra High (EHT)* — The voltage, which normally exceeds 33 kV.

**5B.2.1.80** *Weatherproof* — Accessories, lighting fittings, current-using appliances and cables are said to be of the weatherproof type, if they are so constructed that when installed in open situation they will withstand the effects of rain, snow, dust and temperature variations. For definition of other terms reference may be made to accepted standards [(1) IS 8270].

## **5B.2.2 Symbols**

The architectural symbols that are to be used in all drawings, wiring plans, etc, for electrical installations in buildings shall be as given in Annex A. For other graphical symbols used in electro-technology, reference may be made to Standard practice [(1) IS 8270].

## **5B.3 GENERAL REQUIREMENTS**

**5B.3.1** The installation shall generally be carried out in conformity with the requirements of the Myanmar Electricity Rules and Regulations.

### **5B.3.2 Materials**

All materials, fittings, appliances, etc, used in electrical and allied installations, shall conform to Building Materials' and other related Standards.

### **5B.3.3 Coordination with Local Supply Authority**

- a) In all cases, that is, whether the proposed electrical work is a new installation or extension of an existing one, or a modification involving major changes, the electricity supply undertaking shall be consulted about the feasibility, etc, at an early date.
- b) Addition to an Installation — An addition, temporary or permanent, shall not be made to the authorized load of an existing installation, until it has been definitely ascertained that

## ELECTRICAL AND ALLIED INSTALLATIONS

the current carrying capacity and the condition of existing accessories, conductors, switches, etc, affected, including those of the supply authority are adequate for the increased load. The size of the cable/ conductor shall be suitably selected on the basis of the ratings of the protective devices. Ratings of protective devices and their types shall be based on the installed load, switching characteristics and power factor.

Load assessment and application of suitable diversity factor to estimate the full load current shall be made as a first step. This should be done for every circuit, submain and feeder. Power factor and efficiency of loads shall also be considered. Diversity factor assumed shall be based on one's own experience. Allowance should be made for about 15 percent to 20 percent for extension in near future and the design circuit is calculated for each circuit and submain. The wiring system to be adopted should also be decided in accordance with the environmental requirements. The sizes of wiring cables are decided not merely to carry the load currents, but also to withstand thermal effects of likely over currents and also ensure acceptance level of voltage drop.

### 5B.3.4 Power Factor Improvement in Consumers' Installation

**5B.3.4.1** Conditions of supply of electricity boards or licensees stipulate the lower-limit of power factor which is generally 0.85.

**5B.3.4.2** Principal causes of low power factor are many. For guidance to the consumers of electric energy who take supply at low and medium voltages for improvement of power factor, reference shall be made in accordance with Standard practice [(2) IS 7752].

### 5B.3.5 Execution of Work

Unless otherwise exempted under the appropriate rule of the Myanmar Electricity Rules, the work of electrical installations shall be carried out by a licensed electrical contractor and under the direct supervision of a person holding a certificate of competency and by persons holding a valid permit issued and recognized by any State Government.

**5B.3.6** Safety procedures and practices shall be kept in view during execution of the work in accordance with Standard practice [(4) IS 10118].

**5B.3.7** Safety provisions given in Part 4 'Fire and Life Safety' shall be followed.

## 5B.4 PLANNING OF ELECTRICAL INSTALLATIONS

### 5B.4.1 General

The design and planning of an electrical wiring installation involve consideration of all prevailing conditions, and is usually influenced by the type and requirement of the consumer. A competent electrical design engineer should be involved at the planning stage with a view to providing for an installation that will prove adequate for its intended purpose, and safe and efficient in its use. The information given in **5B.3** shall also be kept in view.

**5B.4.1.1** The design and planning of an electrical wiring installation shall take into consideration, some or all of the following:

- a) the type of supply, occupancy, envisaged load and the earthing arrangement available;
- b) the atmospheric condition, such as cooling air temperature, moisture or such other conditions which are likely to affect the installation adversely;
- c) the possible presence of inflammable or explosive dust, vapour or gas;
- d) the degree of electrical and mechanical protection necessary;

- e) the importance of continuity of service including the possible need for standby supply;
- f) the probability of need for modification or future extension;
- g) the probable operation and maintenance cost taking into account the electricity supply tariffs available;
- h) the relative cost of various alternative methods;
- i) the need for radio and telecommunication interference suppression;
- j) ease of maintenance;
- k) safety aspects;
- l) energy conservation
- m) the importance of proper discrimination between protective devices for continuity of supply and limited isolation of only the affected portion; and
- n) reliable and sustainable electricity supply

**5B.4.1.2** All electrical apparatus shall be suitable for the services these are intended for.

**5B.4.1.3** *Co-ordination*

Proper co-ordination and collaboration between the architect, civil engineer and the electrical and mechanical engineer shall be effected from the planning stage of the installation. The provisions that will be needed for the accommodation of substation, transformer, switch rooms, service cable ducts, rising mains and distribution cables, sub-distribution boards, openings and chases in floors and walls for all required electrical installations, etc, shall be specified in advance.

**5B.4.1.4** Before starting wiring and installation of fittings and accessories, information should be exchanged between the owner of the building/architect/electrical contractor and the local supply authority in respect of tariffs applicable, types of apparatus that may be connected under each tariff, requirement of space for installing meters, switches, etc, and for total load requirements of lights, fans and power.

**5B.4.1.5** While planning an installation, consideration should be taken of the anticipated increase in the use of electricity for lighting, general purpose socket- outlet, kitchen heating, etc. It is essential that adequate provision should be made for all the services which may be required immediately and during the intended useful life of the building, for the householder may otherwise be tempted to carry out extension of the installation himself or to rely upon use of multi-plug adaptors and long flexible cords, both of which are not recommended.

**5B.4.2 LOCATION AND REQUIREMENT OF SUBSTATION**

Information on location and requirements of a substation should cover the following:

**5B.4.2.1** *Location*

- a) The substation should preferably be located in separate building and could be adjacent to the generator room, if any. Location of substation in the basement floors should be avoided, as far as possible.
- b) The ideal location for an electrical substation for a group of buildings would be at the electrical load centre on the ground floor.

## ELECTRICAL AND ALLIED INSTALLATIONS

- c) The floor level of the substation or switch room shall be above the highest flood level of the locality.
- d) Generally the load centre would be somewhere between the geometrical centre and the air conditioning plant room, as air conditioning plant room would normally be the largest chunk of load, if the building is air conditioned.
- e) Substations with oil filled equipment will require great consideration for the fire detection, protection and suppression. Oil cooled transformers require a suitable soak pit with gravity flow to contain the oil in the event of the possibility of oil spillage from the transformer on its failure. Substations with oil filled equipment shall not be located in any floor other than the ground floor or a semi-basement. Such substations with high oil content may be housed in a separate service building or a substation building, which is not the part of a multi-storied building.
- f) In case electric substation has to be located within the main multi-storied building itself for unavoidable reasons, then it should be located on the floor close to ground level, but shall have direct access from the street for operation of the equipments. The provision for installation and removal of substation equipments may be provided from inside the building.
- g) Substations located within a multi-storied building shall not have oil filled transformers, even if it is at the ground level (see Myanmar Fire Department Instruction). Substations with very little combustible material, such as a Dry type transformer, with Vacuum (or SF<sub>6</sub>) HT switchgear and ACB or MCCB for MV can be located in the basement as well as upper floors in a building with high load density in the upper floors. (Some functional buildings such as hospitals, air traffic control towers, computer centers are likely to have high loading in a few upper floors and in such cases, it may be preferable to provide oil-free substations at upper levels. This measure will decrease the current flow at various points, thereby contributing to reduction of vulnerability to fire).
- h) The power supply control to any such substation or transformer (located at basement levels or upper floors) shall be from a location on ground floor/first basement level having direct access from outside so that in case of fire, the electrical supply can be easily disconnected.
- i) Oil filled transformers may be used only in substations located in separate single or two storied service buildings outside the main building structure and there shall at least 6 meter clear distance between the adjoining buildings and substation such that fire tender is able to pass between the two structures.
- j) If dry type transformer is used, it may be located adjacent to medium voltage switchgear in the form of unit type substation. No separate room or fire barrier for the transformer is required, in a substation with oil free equipment. In such a case the room size will decrease. Layout of equipment has to keep the requirement that any one piece of equipment or sub-assembly can be taken out of service and out of the installed location, while keeping the remaining system in service.
- k) The emergency power supply (such as Generating Sets) should not be allowed to be installed above ground floor or below first basement level of building. There shall be provision of separate direct escape and entry into these areas from outside so that in case of fire, electrical supplies can be disconnected to avoid additional losses which may be caused due to electrical supply, present at the time of fire.

- l) For transformers having large oil content (more than 2 000 litres) Myanmar Electricity Rules shall apply.
- m) Facility for connection from substation to adjoining building to feed essential emergency load in that building, such as escape route lighting, fire or sprinkler pumps, emergency communication systems shall be provided. Similarly, the essential emergency load switchboard of this building or building complex should be so as to be capable of receiving power for such loads from the adjoining building or building complex, with its own substation/DG sets shut off due to crisis conditions such as fire,
- n) The availability of power lines nearby may also be kept in view while deciding the location of the substation,
- o) For detailed information regarding location of transformers reference may be made to Standard practice [(3) IS 5216].
- p) All door openings from substation, electrical rooms, etc should open towards outside.

#### **5B.4.2.2** *Type of Building for Substations*

The substations enclosure, that is, walls, floor, ceiling, openings, doors, etc shall have 2 hour fire rating (See Myanmar Fire Department Instructions).

#### **5B.4.2.3** *Layout of Substation*

In allocating the area of substation, it is to be noted that the flow of electric power is from supply company's room to HV room, then to transformer and finally to the medium voltage switchgear room. The layout of the room shall be in accordance with this flow, so as to optimize the cables, bus-trunking etc, Visibility of equipment controlled from the operating point of the controlling switchgear is also a desirable feature, though it may not be achievable in case of large substation.

#### **5B.4.2.4** *Room /Spaces Required*

Generally the following rooms /spaces are required in a substation:

- a) Supply company's switchgear room and/or space for meters.
- b) Capacity and Size — The capacity of a substation depends upon the area of the building and its type. The capacity of substation may be determined based on the following load requirements:
 

After calculating the electrical load on the above basis, a load factor of 70-90 percent is to be applied to arrive at the minimum capacity of substation. The area required for substation and transformer room for different capacities is given in Annex B for general guidance. For reliability, it would be necessary to split the load into more than one transformer and also provide for standby transformer as well as multiple sources, bus-section, etc.
- c) *High Voltage Switch Room*— In case of substation having one transformer and one source of supply, the owner is required to provide one high voltage switch. In case of single point supply with two or more transformers the number of switch required will be one for incoming supply and one for each transformer. In case of duplicate supply two switches shall be provided with mechanical/electrical in locking arrangement where necessary in cables with switches. In case the number of incoming and

## ELECTRICAL AND ALLIED INSTALLATIONS

outgoing switches exceed five, bus coupler of suitable capacity should invariably be provided. The floor area required in case of a single switch is roughly 4 m x 4 m and for every additional switch the length would be increased by 1 m.

Table of Typical Allowances for Diversity

Purpose of Final Circuit Fed from Conductors or Switchgear to which Diversity Applies	Individual Household Installations, including Individual Dwelling of a Block	Type of Premises Small, Shops, Stores Offices and Business Premises	Type of Premises Small Hotels, Boarding Houses etc.
(1)	(2)	(3)	(4)
Heating and power	80% of total current demand up to 10 A +40% of any current demand in excess of 10A	80% full load of largest appliance +60% of remaining appliances	80% full load of largest appliance +60% of second largest appliances +40% of remaining appliances
Lighting	66% of total demand	90% of total current demand	75% of total current demand
Cooking appliances	10A +30% full load of connected cooking appliances in excess of 10 A + 5 A if socket-outlet incorporated in unit	80% full load of largest appliance +60% full load of second largest appliance +50% full load of remaining appliances	80% of largest appliance +60% full load of second largest appliance +50% full load of remaining appliances
Motors (other than lift motors which are subject to special consideration)		80% full load of largest motor +60% full load of second largest motor +50% full load of remaining motors	80% full load of largest motor + 50% full load of remaining motors
Water heater	80% full load of largest appliance +50% of second largest appliance +25% full load of remaining appliances	80% full load of largest appliance +60% of second largest appliance +25% full load of remaining appliances	80% full load of largest appliance +60% of second largest appliance +25% full load of remaining appliances
Floor warming Installations	50%		
Water heaters thermal storage space heating installations	50%		
Standard arrangements of final circuits	80% of current demand of largest circuit +40% of current demand of every other circuit	80% of current demand of largest circuit +50% of current demand of every other circuit	

**ELECTRICAL AND ALLIED INSTALLATIONS**

Socket outlets other than those included above and stationary equipment other than those listed above	80% of current demand of largest point of +40% of current demand of every other point of.	80% of current demand of largest point of +60% of current demand of every other point of	80% of current demand of largest point of +60% of current demand of every point in main rooms (dinning rooms, etc) +40% of current demand of every other point of
---	---	--	---

**NOTES**

- a) For the purpose of the table an instantaneous water heater is deemed to be a water heater of any loading which heats water only while the tap is turned on and therefore uses electricity intermittently.
- b) It is important to ensure that the distribution boards are of sufficient rating to take the total load connected to them without the application of any diversity.
- c) Diversity factor shall apply according to the specific requirement.
- d) Facility for connection from substation of adjoining building to feed emergency loads shall be permitted for feeding escape route and signage lighting as well as selected section of the fire protection system. Similarly on a reciprocal basis facility to feed the adjoining building for such emergency loads may be provided by necessary switchgear.
- e) *Medium Voltage Switch Room* — The floor area required in respect of medium voltage switchgear room may be determined keeping in view the number and type of incoming/outgoing bus coupler switches including likely expansion in future.
- f) *Room for Standby Generator* — It is preferable to install the standby generator in service building. If installed in main building it shall be at the ground floor or at the semi basement, alternatively, in the first basement with facilities for forced ventilation. Adequate space shall be provided for storing of fuel. Compartmentation for fire protection with detection and first-aid protection measures is essential. Different type of requirements exist for the diesel engine and generator for the oil storage area and for the switchgear.
- g) Facilities including space at appropriate positions, relative to the location of the installed equipment has to be kept in the layout design for removal of equipment or sub-assemblies for repair or maintenance. When it is located, other than the ground level with direct equipment access, a hatch or ramp shall be required.
- h) Other environmental requirements under the provisions of Standard Environment Protection Rules, from the aspect of engine emissions including regarding the height of exhaust pipe and permitted noise levels/noise control.
- i) The capacity of standby generating set shall be chosen on the basis of essential light load, essential air conditioning load, essential equipment load and essential services load, such as one lift out of the bank of lifts, one or all water pumps, etc. Having chosen the capacity and number of generating sets, required space may be provided for their installation (see Annex C for general guidance).
- j) The generating set should preferably be housed adjacent to MV switchgear in the substation building to enable transfer of electrical load quickly as well as to avoid transfer

## ELECTRICAL AND ALLIED INSTALLATIONS

of vibration and noise to the main building. Acoustics lining of the room shall be in line with the Standard requirement. If DG Set is located outdoor, it shall be housed in acoustics enclosure. The generator house should have proper ventilation, fire-fighting equipment, etc (*see* Myanmar Fire Department Instruction).

### *k) Requirements of Room*

- 1) The areas given above in respect of the different categories of rooms holds good if they are provided with windows and independent access doors in accordance with local regulations.
  - 2) All the rooms shall be provided with partitions up to the ceiling and shall have proper ventilation. Special care should be taken to ventilate the transformer rooms and where necessary louvers at lower level and exhaust fans at higher level shall be provided at suitable locations.
  - 3) In order to prevent storm water entering the transformer and switch rooms through the soak-pits, the floor level, the substation shall be at least 15 cm above the highest flood water level that may be anticipated in the locality. Also, facility shall be provided for automatic removal of water.
  - 4) The minimum height of high voltage switchgear room shall be 3.6 m below the soffit of the beam.
- l) *Fire Compartmentation* — It is advisable to provide fire compartmentation of buildings and segregation of associated wiring. Busbar trunking of horizontal and vertical distribution type in place of cable based distribution system shall be used.

### **5B.4.3 Location of Switch Room**

In large installations other than where a substation is provided, a separate switch room shall be provided; this shall be located as closely as possible to the electrical load centre preferably near the entrance of the building on the ground floor or on the first basement level, and suitable ducts shall be laid with minimum number of bends from the points of entry of the main supply cable to the position of the main switchgear. The switch room shall also be placed in such a position that rising ducts may readily be provided there from to the upper floors of the building in one straight vertical run. In larger buildings, more than one rising duct may be required and then horizontal ducts may also be required for running cables from the switch room to the foot of each rising main. Such cable ducts shall be either be reserved for the electrical services only or provided with a means of segregation for medium and low voltage installations, such as call-bell systems; telephone installations, fire detection and alarm system, announcement or public address system. Cables for essential emergency services such as those related to fire detection, alarm, announcement should use either metal conduit in addition to physical segregation from power cables or use fire survival cables, so that the service is maintained even in the event of a fire at least for a period of about 20 min.

### **5B.4.4 Location and Requirements of Distribution Panels**

The electrical control gear distribution panels and other apparatus, which are required on each floor may conveniently be mounted adjacent to the rising mains, and adequate space should be provided at each floor for this purpose.

### **5B.4.5 Substation Safety**



The owner or the operator of any substation shall be collectively and severally be responsible for any lapse or neglect leading to an accident or an incidence of an avoidable abnormality and shall take care of the safety requirements as follows:

- a) enclose the substation where necessary to prevent, so far as is reasonably practicable, danger or unauthorized access;
- b) enclose any part of the substation, which is open to the air and contains live equipment which is not encased, with a fence or wall not less than 2.4 m in height to prevent, so far as is reasonably practicable, danger or unauthorised access;
- c) ensure that, so far as is reasonably practicable, there are at all times displayed:
- d) sufficient safety signs of such size and placed in such positions as are necessary to give due warning of such danger as is reasonably foreseeable in the circumstances;
- e) a notice which is placed in a conspicuous position and which gives the location or identification of the substation, the name of each generator or distributor who owns or operates the substation equipment making up the substation and the telephone number where a suitably qualified person appointed for this purpose by the generator or distributor will be in constant attendance; and
- f) such other signs, which are of such size and placed in such positions, as are necessary to give due warning of danger having regard to the sitting of, the nature of, and the measures taken to ensure the physical security of, the substation equipment; and
- g) take all reasonable precautions to minimize the risk of fire associated with the equipment.

#### **5B.4.6 Overhead Lines, Wires and Cables**

##### **5B.4.6.1 Height Requirement**

While overhead lines may not be relevant within buildings, regulations related to overhead lines are of concern from two different angles.

- a) Overhead lines may be required in building complexes, though use of underground cables is the preferred alternative.
- b) Overhead lines may be passing through the site of a building. In such a case the safety aspects are important for the construction activity in the vicinity of the overhead line as well as portions of low height buildings that may have to be constructed below the overhead lines. For minimum distance (vertical and horizontal) of electric lines/wires/cables from buildings, reference may be made to General Building Requirement of Myanmar.
- c) Any person responsible for erecting an overhead line will keep informed the authority(s) responsible for services in that area for telecommunication, gas distribution, water and sewage network, roads so as to have proper co-ordination to ensure safety. He shall also publish the testing, energizing programme for the line in the interests of safety.

##### **5B.4.6.2 Position, Insulation and Protection of Overhead Lines**

Any part of an overhead line which is not connected with earth and which is not ordinarily accessible shall be supported on insulators or surrounded by insulation. Any part of an overhead line which is not connected with earth and which is ordinarily accessible shall be:

- a) made dead; or
- b) so insulated that it is protected, so far it is reasonably practicable, against mechanical damage or interference; or
- c) adequately protected to prevent danger.

Any person responsible for erecting a building or structure which will cause any part of an overhead line which is not connected with earth to become ordinarily accessible shall give reasonable notice to the generator or distributor who owns or operates the overhead line of his intention to erect that building or structure.

Any bare conductor not connected with earth, which is part of a low voltage overhead line, shall be situated throughout its length directly above a bare conductor which is connected with earth.

No overhead line shall, so far as is reasonably practicable, come so close to any building, tree or structure as to cause danger.

In this regulation the expression "ordinarily accessible" means the overhead line could be reached by hand if any scaffolding, ladder or other construction was erected or placed on/in, against or near to a building or structure.

#### **5B.4.6.3** *Precautions Against Access and Warnings of Dangers*

Every support carrying a high voltage overhead line shall, if the circumstances reasonably require, be fitted with devices to prevent, so far it is reasonably practicable, any unauthorized person from reaching a position at which any such line would be a source of danger.

Every support carrying a high voltage overhead line, and every support carrying a low voltage overhead line incorporating bare phase conductors, shall have attached to it sufficient safety signs and placed in such positions as are necessary to give due warning of such danger as is reasonably foreseeable in the circumstances.

Poles supporting overhead lines near the road junction and turnings shall be protected by a masonry or earth fill structure or metal barricade, to prevent a vehicle from directly hitting the pole, so that the vehicle, if out of control, is restrained from causing total damage to the live conductor system, likely to lead to a hazardous condition on the road or foot path or building.

#### **5B.4.6.4** *Fitting of Insulators to Stay Wires*

Every stay wire which forms part of, or is attached to, any support carrying an overhead line incorporating bare phase conductors (except where the support is a lattice steel structure or other structure entirely of metal and connected to earth) shall be fitted with an insulator no part of which shall be less than 3 m above ground or above the normal height of any such line attached to that support.

### **5B.4.7 Maps of Underground Networks**

**5B.4.7.1** Any person or organization or authority laying cables shall contact the local authority in charge of that area and find out the layout of

- a) water distribution pipe lines in the area;
- b) sewage distribution network;
- c) telecommunication network; and
- d) gas pipeline network and plan the cable network in such a manner that the system is compatible, safe and non interfering either during its installation or during its

operation and maintenance. Plan of the proposed cable installation shall be brought to the notice of the other authorities referred above.

**5B.4.7.2** Suitable cable markers and danger sign as would be appropriate for the safety of the workmen of any of the systems shall be installed along with the cable installation. Notification of testing and energisation of the system shall also be suitably published for ensuring safety.

**5B.4.7.3** Any person or organization or authority laying cables shall have and, so far it is reasonably practicable, keep up to date, a map or series of maps indicating the position and depth below surface level of all networks or parts there of which he owns or operates.

Any map prepared or kept shall be available for inspection by any of the municipal authority, other service providers, general public provided they have a reasonable cause for requiring to inspect any part of the map.

## **5B.5 DISTRIBUTION OF SUPPLY AND CABLING**

### **5B.5.0 General**

In the planning and design of an electrical wiring installation, due consideration shall be made of all the prevailing conditions. It is recommended that advice of a competent electrical engineer be sought at the initial stage itself with a view to providing an installation, that will prove adequate for its intended purpose be reliable and safe and efficient.

A certain redundancy in the electrical system is necessary and has to be built in from the initial design stage itself. The extent of redundancy will depend on the type of load, its criticality, normal hours of use, quality of power supply in that area, co-ordination with the standby power supply, capacity to meet the starting current requirements of large motors etc.

### **5B.5.1 System of Supply**

**5B.5.1.1** All electrical apparatus shall be suitable for the voltage and frequency of supply.

**5B.5.1.2** In case of connected load of 100 kVA and above, the relative advantage of high voltage three-phase supply should be considered. Though the use of high voltage supply entails the provisions of space for the capital cost of providing suitable transformer substation at the consumer's premises, the following advantages are gained:

- a) advantage in tariff;
- b) more effective earth fault protection for heavy current circuits;
- c) elimination of interference with supplies to other consumers permitting the use of large size motors, welding plant, etc; and
- d) better control of voltage regulation and more constant supply voltage.

NOTE — Additional safety precautions required to be observed in HV installations shall also be kept in view.

In many cases there may be no choice available to the consumer, as most of the licensees have formulated their policy of correlating the supply voltage with the connected load or the contract demand. Generally the supply is at 400/230 volts, 11 kV for loads up to 1 MVA and 33 kV or 66 kV for consumers of more than 1 MVA.

**5B.5.1.3** In very large industrial buildings where heavy electric demands occur at scattered locations, the economics of electrical distribution at high voltage from the main substation to other subsidiary transformer substations or to certain items of plant, such as large motors and furnaces, should be considered. The relative economy attainable by use of medium or high voltage distribution and high voltage plant is a matter for expert judgement and individual assessment in the light of experience by a professionally qualified electrical engineer.

### **5B.5.2 Substation Equipment and Accessories**

Substations require an approval by the Electrical Inspectorate. Such approval is mandatory before energizing the substation. It is desirable to get the approval for the general layout, schematic layout, protection plan etc, before the start of the work from the Inspectorate. All substation equipment and accessories and materials, etc, shall conform to relevant Standards wherever they exist, otherwise the consumer (or his consultant) has to specify the standards to which the equipment to be supplied conforms and that shall be approved by the authority. Manufacturers of equipment have to furnish certificate of conformity as well as type test certificates for record, in addition to specified test certificates for acceptance tests and installation related tests for earthing, earth continuity, load tests and tests for performance of protective gear.

#### **5B.5.2.1 High Voltage Switchgear**

**5B.5.2.1.1** The selection of the type of high voltage switchgear for any installation inter alia depends upon the following:

- a) voltage of the supply system;
- b) the prospective short-circuit current at the point of supply;
- c) the size and layout of electrical installation;
- d) the accommodation available; and
- e) the nature of industry.

Making and breaking capacity of switchgear shall be commensurated with short-circuit potentialities of the supply system and the supply authority shall be consulted on this subject.

**5B.5.2.1.2** Guidelines on various types of switchgear equipment and their choice for a particular application shall be in accordance with Standard practice [(4) IS 10118].

**5B.5.2.1.3** In extensive installations of switchgear (having more than four incoming supply cables or having more than 12 circuit breakers), banks of switchgears shall be segregated from each other by means of fire resisting barriers having 2h fire resistance rating in order to prevent spreading of the risk of damage by fire or explosion arising from switch failure. Where a bus-bar section switch is installed, it shall also be segregated from adjoining banks in the same way [(5) IS 1646]. Except main LT panel, it would be preferable to locate the sub panels/distribution boards near load centre. Further, it should be ensured that these panels are easily approachable. The preferable location of panels shall be near the exitways.

**5B.5.2.1.4** It should be possible to isolate any section from the rest of the switchboards such that work might be undertaken on this section without the necessity of making the switchboard dead. Isolating switches used for the interconnection of sections or for the purpose of isolating circuit-breakers of other apparatus, shall also be segregated within its compartment so that no live part is accessible when work in a neighbouring section is in progress.

**5B.5.2.1.5** In the case of duplicate or ring main supply, switchgears with interlocking arrangement shall be provided to prevent simultaneous switching of two different supply sources. Electrical and/or mechanical interlocks may preferably be provided.

#### **5B.5.2.2 Cables**

**5B.5.2.2.1** The smallest size of the cable that shall be used, will depend upon the method of laying cable permissible maximum temperature it shall withstand, voltage drop over the length of the cable, the prospective short-circuit current to which the cable may be subjected, the characteristics of the overload protection gear installed, load cycle and thermal resistivity of the soil [(6) IS 732].

NOTE — Guidelines for correlation of the ratings of cables and characteristics of protective devices are under consideration. Continuous current carrying capacity (thermal limit leading to permanent change in properties of the insulation) under the installed conditions, voltage drop under required load and the fault current withstand ability of the cable for the duration that the protective device controlling the cable installation will let go the fault current, operating voltage are the prime considerations.

**5B.5.2.2.2** The advice of the cable manufacturer with regard to installation, jointing and sealing shall be followed.

**5B.5.2.2.3** The HV cables shall either be laid on the cable rack/built-up concrete trenches/tunnel/basement or directly buried in the ground depending upon the specific requirement. It is preferable to use four core cable in place of three and half core to minimize heating of neutral core due to harmonic content in the supply system and also avoidance of overload failures. All cables shall be installed in accordance with Standard practice [(6) IS 732].

#### **5B.5.2.2.4 Colour identification of cores of non-flexible cables**

<i>Function</i>	<i>Colour Identification of Core of Rubber of PVC Insulated Non flexible Cable, or of Sleeve or Disc to be Applied to Conductor or Cable Code</i>
Protective or earthing	Green and yellow or Green with yellow stripes <sup>1)</sup>
Neutral of a.c. single or three phase circuit	Blue
Phase R of 3-phase a.c. circuit	Brown
Phase Y of 3-phase a.c. circuit	Black
Phase B of 3-phase a.c. circuit	Grey
Positive of d.c. 2-wire circuit	Brown
Negative of d.c. 2-wire circuit	Grey
Outer (positive or negative) of d.c. 2-wire circuit derived from 3-wire system	Brown/Grey
Positive of 3-wire system positive of 3-wire d.c. circuit)	Brown

**ELECTRICAL AND ALLIED INSTALLATIONS**

Middle wire of 3-wire d.c. circuit	Blue
Negative of 3-wire d.c. circuit	Grey
Functional Earth-Telecommunication	Cream

1) Bare conductors are also used for earthing and earth continuity conductors. But it is preferable to use insulated conductors with green insulation with yellow stripes.

**5B.5.2.2.5 Colour, identification of cores of flexible cables and flexible cords**

<i>Number of Cores</i>	<i>Function of Core</i>	<i>Colour(s) of Core</i>
1	Phase	Brown <sup>1)</sup>
	Neutral	(Light) Blue
	Protective or Earthing	Green & yellow
2	Phase	Brown
	Neutral	(Light) Blue <sup>1)</sup>
3	Phase	Brown
	Neutral	(Light) Blue <sup>1)</sup>
	Protective or Earthing	Green & yellow
4 or 5	Phase	Brown, Black <sup>1)</sup> , Grey
	Neutral	(Light) Blue <sup>1)</sup>
	Protective or Earthing	Green & yellow

<sup>1)</sup> Certain alternative are allowed in Wiring Regulations.

**5B.5.2.3 High Voltage Bus bar Trunking/Ducting**

High voltage busbar trunking system is a type-tested switchgear and control gear assembly in the form of an enclosed system. HV busbar system is used for transporting power between HV Generators, transformers and the infeed main switchgear of the main HV switchgear.

Generally three types of bus ducts namely non-segregated, segregated and isolated phase bus duct shall be used. The non-segregated bus ducts consists of three phase busbars running in a common enclosure made of steel or aluminium. The enclosure shall provide safety for the operational personnel and reduces chances of faults. The enclosures shall be effectively grounded.

Segregated phase bus duct are similar to non-segregated phased duct except that metal or insulation barriers are provided between phase conductors to reduce chances of phase to phase faults. However, it is preferable to use metal barriers.

In the case of isolated bus ducts, each phase conductor shall be housed in a separate non-magnetic enclosures. The bus duct shall be made of sections which are assembled together at site to make complete assembly. The enclosure shall be of either round or square shape and

welded construction. The enclosures of all phases in general to be supported on a common steel structure. Provision of fire protection shall be provided in all openings' [see Myanmar Fire Department Instruction]. Fire separation in openings shall be provided using materials having 2h fire resistance rating.

#### **5B.5.2.4 MV/LV Busbar Trunking/Rising Mains**

Where heavy loads are to be carried, busbar systems are preferred. The busbars are available for continuous run from point to point or with tap offs at standard intervals and have to be chosen as per specific requirement. MV/LV busbar trunking shall be a type-tested switchgear and control gear assembly in the form of an enclosed system. There are two types of MV/LV bus duct system for power distribution system:

- a) Conventional type.
- b) Compact and sandwich type.

Conventional type bus duct is used for large power handling between transformer and switchgear or between switchgear and large power loads, such as compressor drive motor etc. This type is generally used in plant rooms, riser shafts, substations etc.

Compact type is available either air insulated or sandwich type for use within areas of the building which are put to other higher (aesthetic) level of use. They could be used in false ceiling spaces or even in corridors and shafts for distribution without any false ceiling as they provide an aesthetically acceptable finish to merge with other building elements such as beams, ducts or pipes in functional buildings.

The class of protection shall be specific depending on the requirement at the place of installation. Protection class (IP xx) will automatically identify the ventilation, protection from weather, water, dust etc.

In modern building technology, high demands are made of the power distribution system and its individual components:

- a) Long life and good service quality,
- b) Safe protection in the event of fire,
- c) Low fire load,
- d) Low space requirement, and
- e) Minimum effort involved in carrying out retrofits.

The high load density in modern large buildings and high rise buildings demands compact and safe solution for the supply of power. The use of busbar trunking system is ideal for such applications.

Bus bar trunking can be installed in vertical risers ducts or horizontally in passages for transmission and distribution of power. Busbar trunking systems allow electrical installations to be planned in a simple and clear fashion. In the building complexes, additional safety demands with respect to fire barriers and fire load and use of bus bar trunking meets this requirement.

Busbar trunking system reduces the combustible material near the area with high energy in comparison with other distribution systems such as cables and makes the building safe from the aspect of vulnerability to fire of electrical origin. In addition, unlike cable systems the

reliability of a bus trunking system is very high. These systems also require very little periodic maintenance.

Choice of busbar trunking for distribution in building can be made on the basis of

- a) reduced fire load (drastically reduced in comparison to the cable system),
- b) reduced maintenance over its entire lifetime,
- c) longer service lifetime in comparison with a cable distribution
- d) enhanced reliability due to rigid bolted joints and terminations and extremely low possibility of insulation failure.

#### **5B.5.2.5 Transformers**

**5B.5.2.5.1** General design objective while selecting the transformer(s) for a substation would be to provide at least two or more transformers, so that a certain amount of redundancy is built in, even if a standby system is provided. The total installed transformation capacity would be marginally higher than the anticipated maximum demand. With growing emphasis on energy conservation, the system design is made for both extremes of loading. During the periods of lowest load in the system, it would be desirable to operate only one transformer and switch in additional transformers as the load variation takes place in a day. The minimum size of a transformer would quite often depend on the minimum load that is anticipated over a period of about 4 h in a day. Total transformer capacity is generally selected on the basis of present load, possible future load, operation and maintenance cost and other system conditions and selection of the maximum size (capacity) of the transformer is guided by short-circuit making and breaking capacity of the switchgear used in the medium voltage distribution system. Maximum size limitation is important from the aspect of feed to a down stream fault.

For feeding final single phase domestic type of loads or general office loads it is advisable to even use transformers of capacity much lower than what the switchgear can handle, so that lower fault MVA is available in such areas and use of hand held equipment fed through flexible cords is safe.

For reasons of reliability and redundancy it is normal practice to provide at least two transformers for any important installation. Interlinking by tie lines is an alternative to enhance reliability/redundancy in areas where there are a number of substations in close vicinity, such as a campus with three or four multi-storied blocks each with a substation.

Ring main type of distribution is preferred for complexes having a number of substations.

**5B.5.2.5.2** Where two or more transformers are to be installed in a substation to supply a medium voltage distribution system, the distribution system shall be divided into separate sections each of which shall be normally fed from one transformer only unless the medium voltage switchgear has the requisite short circuit capacity. Provision may, however, be made to interconnect separate sections, through a bus coupler in the event of failure or disconnection of one transformer. See **5B.4.2** for details of location and requirements of substation.

The transformers, that may at any time operate in parallel, shall be so selected as to share the load in proportion to their respective load ratings. While the general practice is to avoid operation of transformers in parallel for feeding final distribution in buildings, it is possible to use transformers with slightly different impedance or voltage taps to operate in parallel, but with appropriate protection. Installations designed for parallel operation of



transformers shall have protection for avoiding circulating current between transformers, avoid overload of any one transformer due to reactance mismatch and the system shall be so arranged as to trip the secondary breaker in case the primary breaker of that transformer trips.

#### **5B.5.2.6 Switchgear**

**5B.5.2.6.1** Switchgear (and its protective device) shall have breaking capacity not less than the anticipated fault level in the system at that point. System fault level at a point in distribution system is predominantly dependent on the transformer size and its reactance. Parallel operation of transformers naturally increases the fault level.

**5B.5.2.6.2** Isolation and controlling circuit breaker shall be interlocked so that the isolator cannot be operated unless the corresponding breaker is in open condition. The choice between alternative types of equipment may be influenced by the following considerations:

- a) In certain installations supplied with electric power from remote transformer substations, it may be necessary to protect main circuits with circuit-breakers operated by earth fault, in order to ensure effective earth fault protection.
- b) Where large electric motors, furnaces or other heavy electrical equipment is installed, the main circuits shall be protected from short circuit by switch disconnector fuse or circuit breakers. For motor protection, the combination of contactor overload device and fuse or circuit breakers shall be Type-2 coordinated in accordance with accepted standards [(7) IS 13947]. Wherever necessary, backup protection and earth fault protection shall be provided to the main circuit.
- c) Where mean of isolating main circuits is separately required, switch disconnector fuse or switch disconnector may form part of main switchboards.

**5B.5.2.6.3** It shall be mandatory to provide power factor improvement capacitor at the substation bus. Suitable capacitor may be selected in consultation with the capacitor as well as switchgear manufacture depending upon the nature of electrical load anticipated on the system. Necessary switchgear/feeder circuit breaker shall be provided for controlling of capacitor bank.

Power factor of individual motor may be improved by connecting individual capacitor banks in parallel. For higher range of motors, which are running continuously without much variation in load, individual power factor correction at load end is advisable.

NOTE — Care should be taken in deciding the kVA rating of the capacitor in relation to the magnetizing kVA of the motor. Over rating of the capacitor may cause injury to the motor and capacitor bank. The motor still rotating after disconnection from the supply, may act as generator by self-excitation and produce a voltage higher than supply voltage. If the motor is again switched on before the speed has fallen to about 80 percent of the normal running speed, the high voltage will be superimposed on the supply circuits and will damage both the motor and capacitor.

As a general rule, the kVAr rating of the capacitor should not exceed the no-load magnetizing kVA of the motor.

## ELECTRICAL AND ALLIED INSTALLATIONS

Generally it would be necessary to provide an automatic control for switching in capacitors matching the load power factor and the bus voltage. Such a scheme would be necessary as capacitors permanently switched in the circuit may cause over voltage at times of light load.

**5B.5.2.6.4** Sufficient additional space shall be allowed in substations and switch rooms to allow operation and maintenance and proper means shall be provided for isolating the equipment to allow access for servicing, testing and maintenance. Sufficient additional space shall be allowed for temporary location and installation of standard servicing and testing equipment. Space should also be allowed to provide for anticipated future extensions.

**5B.5.2.6.5** Electrical installations in a room or cubicle or in an area surrounded by wall fence, access to which is controlled by lock and key shall be considered accessible to authorized persons only.

A wall or fence less than 1.8 m in height shall not be considered as preventing access unless it has other features that provide a degree of isolation equivalent to a 1.8 m fence.

**5B.5.2.6.6** Harmonics on the supply systems are becoming a greater problem due to the increasing use of electronic equipments, computer, fluorescent, mercury vapour and sodium vapour lighting, controlled rectifier and inverters for variable speed drives, power electronics and other non-linear loads. Harmonics may lead to almost as much current in the neutral as in the phases. This current is almost entirely third harmonic. Phase rectification devices may be considered for the limits of harmonic voltage distortion may be considered at the planning stage in such cases.

With the wide spread use of thyristor and rectifier based loads there is necessity of providing a full size neutral; but this requirement is limited to the 3-phase 4-wire distribution generally in the 400/230V system. As a result it is not desirable to use half-size neutral conductor, as possibility of neutral conductor overload due to harmonics is likely.

### **5B.5.3 Reception and Distribution of Main Supply**

#### **5B.5.3.1 Control at Point of Commencement of Supply**

**5B.5.3.1.1** There shall be a circuit-breaker or miniature circuit-breakers or a load break switch fuse on each live conductor of the supply mains at the point of entry. The wiring throughout the installation shall be such that there is no switch or fuse unit in the earthed neutral of conductor. The neutral shall also be distinctly marked.

**5B.5.3.1.2** The main switch shall be easily accessible and situated as near as practicable to the termination of service line.

**5B.5.3.1.3** On the main switch, where the conductors include an earthed conductor of a two-wire system or an earthed neutral conductor or a multi-wire system or a conductor which is to be connected thereto, an indication of a permanent nature shall be provided to identify the earthed neutral conductor.

#### **5B.5.3.1.4 Energy meters**

Energy meters shall be installed in residential buildings at such a place which is readily accessible to the owner of the building and the Authority. These should be installed at a height where it is convenient to note the meter reading, it should preferably not be

installed below one metre from the ground. The energy meters should either be provided with a protecting covering, enclosing it completely except the glass window through which the readings are noted or should be mounted inside a completely enclosed panel provided with hinged or sliding doors with arrangement for locking.

In multi-storied buildings meters shall be installed with tapping point for meters of the rising main (bus trunking) on individual floors (Energy Meter Installed Location subject to the requirement of Electricity Supply Authority).

#### **5B.5.3.2 Main Switches and Switchboard**

**5B.5.3.2.1** All main switches shall be either of metal-clad enclosed pattern or of any insulated enclosed pattern which shall be fixed at close proximity to the point of entry of supply. Every switch shall have an environmental protection level rating (IP), so that its operation is satisfactory in the environment of the installation.

NOTE — Woodwork shall not be used for the construction or mounting of switches and switch boards installed in' a building.

#### **5B.5.3.2.2 Location**

- a) The location of the main board should be such that it is easily accessible for fireman and other personnel to quickly disconnect the supply in case of emergencies. If the room is locked for security, means of emergency access, by schemes such as break glass cupboard, shall be incorporated.
- b) Main switch board shall be installed in rooms or cupboards so as to safeguard against operation by unauthorized personnel.
- c) Switchboards shall be placed only in dry situations and in ventilated rooms and they shall not be placed in the vicinity of storage batteries or exposed to chemical fumes.
- d) In damp situation or where inflammable or explosive dust, vapour or gas is likely to be present, the switchboard shall be totally enclosed and shall have adequate degree of protection. In some cases flameproof enclosure may be necessitated by particular circumstances [(8) IS 2148].
- e) Switchboards shall not be erected above gas stoves or sinks, or within 2.5 m or any washing unit in the washing rooms or laundries, or in bathrooms, lavatories or toilets, or kitchens.
- f) In case of switchboards unavoidably fixed in places likely to be exposed to weather, to drip, or to abnormal moist temperature, the outer casing shall be weatherproof and shall be provided with glands or bushings or adopted to receive screwed conduit, according to the manner in which the cables are run.
- g) Adequate illumination shall be provided for all working spaces about the switchboards when installed indoors.

**5B.5.3.2.3** Metal-clad switchgear shall preferably be mounted on any of the following types of boards:

- a) *Hinged-type metal boards* — These shall consist of a box made of sheet metal not less than 2 mm thick and shall be provided with a hinged cover to enable the board to swing open for examination of the wiring at the back. The joints shall be

## ELECTRICAL AND ALLIED INSTALLATIONS

welded. There shall be a clear distance of not less than 2.5 cm between the teak wood board and the cover, the distance being increased for larger boards in order that on closing of the cover, the insulation of the cables is not subjected to damage and no excessive twisting or bending in any case. The board shall be securely fixed to the wall by means of rag bolts, plugs, or wooden plugs and shall be provided with a locking arrangement and an earthing stud. All wires passing through the metal board shall be protected by a rubber or wooden bush at the entry hole. The earth stud should commensurate with the size of earth lead/leads. Alternatively, metal boards may be made of suitable size angle iron of minimum size 35 mm x 35 mm x 6 mm or channel iron of minimum size 35 mm x 25 mm x 6 mm frames work suitably mounted on front with a 3 mm thick mild steel plate and on back with 1.5 mm thick mild steel sheet. No apparatus shall project beyond any edge of panel. No fuse body shall be mounted within 2.5 cm of any edge of the panel.

NOTE — Such type of boards are particularly suitable for small switchboard for mounting metal-clad switchgear connected to supply at low voltages.

- b) *Fixed-type metal boards* — These shall consist of an angle or channel iron frame fixed on the wall or on floor and supported on the wall at the top, if necessary. There shall be a clear distance of 1 m in front of the switchboards. If there are any attachments of bare connections at the back of the switchboard *Myanmar Electricity Rules* shall apply. The connections between the switchgear mounting and the outgoing cable up to the wall shall be enclosed in a protection pipe.

NOTE — Such type of boards are particularly suitable for large switchboards for mounting large number of switchgears or high capacity metal-clad switchgear or both.

- c) *Protected-type switchboard* — A protected switchboard is one where all of the conductors are protected by metal or other enclosures. They may consist of a metal cubicle panel, or an iron frame upon which is mounted metal clad switchgear. They usually consist of a main switch, busbars and circuit breakers or fuses controlling outgoing circuits.
- d) *Open-type switchboard* — An open type switchboard is one, which has exposed current carrying parts on the front of the switchboard. This type of switchboard is rarely used nowadays but where this exists, a hand rail or barrier has to be provided to prevent unintentional or accidental contact with exposed live parts. They must be located in a special switch room or enclosure and only a competent person may have access to these switchboards.

NOTE—These boards may be existing in old installations. It is recommended that they be phased out. With the continuously increasing fault power feed due to increases in generation and strengthening of distribution systems, these open boards are a source of accidents.

### 5B.5.3.2.4 Recessing of boards

Where so specified, the switchboards shall be recessed in the wall. Ample room shall be provided at the back for connection and at the front between the switchgear mountings.

### 5B.5.3.2.5 Marking of apparatus [see (9) IS 5578]

- a) Where a board is connected to voltage higher than 250 V, all the apparatus mounted on it shall be marked on the following colors to indicate the different poles or phases to which the apparatus or its different terminals may have been connected:

*Alternating Current*

Three-phases — Brown, Black, Grey

1 Neutral —Blue

*Direct Current*

Three-wire system— 2 outer wire, positive Brown and negative Grey

1 Neutral —Blue

- b) Where four-wire three-phase wiring is done, the neutral shall be in one colour and the other three wires in another colour as mentioned above or shall be suitably tagged or sleeved for fool proof identification.
- c) Where a board has more than one switch, each such switch shall be marked to indicate which section of the installation it controls. The main switch shall be marked as such and where there is more than one main switch in the building, each such switch shall be marked to indicate which section of the installation it controls.

All markings shall be clear and permanent.

**5B.5.3.2.6 Drawings**

Before proceeding with the actual construction, a proper drawing showing the detailed dimensions and design including the disposition of the mountings of the boards, which shall be symmetrically and neatly arranged for arriving at the overall dimensions, shall be prepared along the building drawing. Such drawings will show the mandatory clearance spaces if any, and clear height below the soffit of the beam required to satisfy regulations and safety considerations, so that other designers or installers do not get into such areas or spaces for their equipment.

**5B.5.3.2.7** Where a board has more than one switch, each such switch shall be marked to indicate which section of the installation it controls. The main switch shall be marked as such and where there is more than one main switch in the building, each such switch shall be marked to indicate which section of the installation it controls.

All markings shall be clear and permanent.

**5B.5.3.2.8 MV/LV Bus bar chambers (400 V/230 V)**

Busbar chambers, which feed two or more circuits, must be controlled by a main disconnector (TP & N), or Isolating links or TPN MCB to enable them to be disconnected from the supply.

**5B.5.3.3 Distribution Boards**

A distribution board comprises of one or more protective devices against over current and ensuring the distribution of electrical energy to the circuits. Distribution board shall provide plenty of wiring space, to allow working as well as to allow keeping the extra length of connecting cables, likely to be required for maintenance.

**5B.5.5.3.1** Main distribution board shall be provided with a circuit breaker on each pole of each circuit, or a switch with a fuse on the phase or live conductor and a link on the neutral or earthed conductor of each circuit. The switches shall always be linked.

All incomers should be provided with surge protection devices.

#### **5B.5.3.4 Branch Distribution Boards**

**5B.5.3.4.1** Branch distribution boards shall be provided, along with earth leakage protective device (ELCB) (incoming), with a fuse or a miniature circuit breaker or both of adequate rating/setting chosen on the live conductor of each sub-circuit and the earthed neutral conductor shall be connected to a common link and be capable of being disconnected individually for testing purposes. At least one spare circuit of the same capacity shall be provided on each branch distribution board. Further, the individual branching circuits (outgoing) shall be protected against over-current with miniature circuit breaker of adequate rating. In residential/industrial lighting installations, the various circuits shall be separated and each circuit shall be individually protected so that in the event of fault, only the particular circuit gets disconnected.

**5B.5.3.4.2** Circuits shall be separate for installations at higher level such as those in the ceiling and at higher levels, above 1 m, on the walls and for installations at lower level such as sockets for portable or stationery plug in equipments. For devices consuming high power and which are to be supplied through supply cord and plug, separate wiring shall be done. For plug-in equipment provisions shall be made for providing ELCB protection in the distribution board.

**5B.5.3.4.3** It is preferable to have additional circuit for kitchen and bathrooms. Such sub-circuit shall not have more than a total of ten points of light, fans and 6A socket outlets. The load of such circuit shall be restricted to 800 W. If a separate fan circuit is provided, the number of fans in the circuit shall not exceed ten. Power sub-circuit shall be designed according to the load but in no shall there be more than two 16A outlets on each sub-circuit.

**5B.5.3.4.4** The circuits for lighting of common area shall be separate. For large halls 3-wire control with individual control and master control installed near the entrance shall be provided for effective conservation of energy.

**5B.5.3.4.5** Where daylight would be available, particularly in large halls, lighting in the area near the windows, likely to receive daylight shall have separate controls for lights, so that they can be switched off selectively when daylight is adequate, while keeping the lights in the areas remote from the windows on.

**5B.5.3.4.6** Circuits for socket outlets may be kept separate circuits feeding fans and lights. Normally, fans and lights may be wired on a common circuit. In large spaces circuits for fans and lights may also be segregated. Lights may have group control in large halls and industrial areas. While providing group control consideration may be given for the nature of use of the area lit by a group. Consideration has to be given for the daylight utilization, while grouping, so that a group feeding areas receiving daylight can be selectively switched off during daylight period.

**5B.5.3.4.7** The load on any low voltage sub-circuit shall not exceed 3000 W. In case of a new installation, all circuits and sub-circuits shall be designed with an initial load of about 2 500 W, so as to allow a provision of 20 percent increase in load due to any future modification. Power sub-circuits shall be designed according to the load, where the circuit

is meant for a specific equipment. Good practice is to limit a circuit to a maximum of four sockets, where it is expected that there will be diversity due to use of very few sockets in large spaces (example sockets for use of vacuum cleaner). General practice is to limit it to two sockets in a circuit, in both residential and non-residential buildings and to provide a single socket on a circuit for a known heavy load appliance such as air conditioner, cooking range etc.

**5B.5.3.4.8** In wiring installations at special places like construction sites, stadium, shipyards, open yards in industrial plants, etc, where a large number of high wattage lamp may be required, there shall be no restriction of load on any circuit but conductors used in such circuits shall be of adequate size for the load and proper circuit protection shall be provided.

#### **5B.5.3.5 Location of Distribution Boards**

- a) The distribution boards shall be located as near as possible to the centre of the load they are intended to control.
- b) These shall be fixed on suitable stranchion or wall and shall be accessible for replacement/reset of protective devices, and shall not be more than 1.8 m from floor level.
- c) These shall be of either metal-clad type, or air insulated type. But, if exposed to weather or damp situations, these shall be of the weatherproof type and, if installed where exposed to explosive dust, vapour or gas, these shall be of flameproof type in accordance with accepted standards. In corrosive atmospheres, these shall be treated with anti-corrosive preservative or covered with suitable plastic compound.
- d) Where two and/or more distribution boards feeding low voltage circuits are fed from a supply of medium voltage, the metal case shall be marked 'Danger 400 V' and identified with proper phase marking and danger marks.
- e) Each shall be provided with a circuit list giving diagram of each circuit which it controls and the current rating of the circuit and size of fuse element.
- f) In wiring branch distribution board, total load of consuming devices shall be divided as far as possible evenly between the number of ways in the board leaving spare circuits for future extension.

#### **5B.5.3.6 Protection of Circuits**

- a) Appropriate protection shall be provided at switchboards, distribution boards and at all levels of panels for all circuits and sub-circuits against short circuit, over-current and other parameters as required. The protective device shall be capable of interrupting maximum prospective short circuit current that may occur, without danger. The ratings and settings of fuses and the protective devices shall be co-ordinated so as to afford selectivity in operation and in accordance with accepted standards [(1) IS 8270].
- b) Where circuit-breakers are used for protection of a main circuit and of the sub-circuits derived there from, discrimination in operation may be achieved by adjusting the protective devices of the sub-main circuit-breakers to operate at lower current settings and shorter time-lag than the main circuit-breaker.

## ELECTRICAL AND ALLIED INSTALLATIONS

- c) Where HRC type fuses are used for back-up protection of circuit-breakers, or where HRC fuses are used for protection of main circuits, and circuit-breakers for the protection of sub-circuits derived there from, in the event of short-circuits protection exceeding the short circuits capacity of the circuit-breakers, the HRC fuses shall operate earlier than the circuit-breakers; but for smaller overloads within the short-circuit capacity of the circuit breakers, the circuit-breakers shall operate earlier than the HRC fuse blows.
- d) If rewirable type fuses are used to protect sub-circuits derived from a main circuit protected by HRC type fuses, the main circuit fuse shall normally blow in the event of a short-circuit or earth fault occurring on sub-circuit, although discrimination may be achieved in respect of overload currents. The use of rewirable fuses is restricted to the circuits with short-circuit level of 4 kA; for higher level either cartridge or HRC fuses shall be used. However, use of rewirable fuses not desirable, even for lower fault level areas. MCB's provide a better and dependable protection, as their current setting is not temperable.
- e) A fuse carrier shall not be fitted with a fuse element larger than that for which the carrier is designed.
- f) The current rating of a fuse shall not exceed the current rating of the smallest cable in the circuit protected by the fuse.
- g) Every fuse shall have its own case or cover for the protection of the circuit and an indelible indication of its appropriate current rating in an adjacent conspicuous position.

### 5B.5.4 Voltage and Frequency of Supply

It should be ensured that all equipment connected to the system including any appliances to be used on it are suitable for the voltage and frequency of supply of the system. The nominal values of low and medium voltage systems in Myanmar are 230 V and 400 V ac, respectively, and the frequency 50 Hz.

NOTES—The design of the wiring system and the sizes of the cables should be decided taking into account two factors.

- a) *Voltage Drop*— This should be kept as low as economy permits to ensure proper functioning of all electrical appliances and equipment including motors; and
- b) First cost against operating losses.

### 5B.5.5 Rating of Cables and Equipments

**5B.5.5.1** The current-carrying capacity of different types of cables shall be chosen in accordance with Standard practice [(12) IS 3961].

**5B.5.5.2** The current ratings of switches for domestic and similar purposes are 6A and 16A.

**5B.5.5.3** The current ratings of isolators and normal duty switches and composite units of switches and fuses shall be selected from one of the following values:

16, 25, 32, 63, 100, 160, 200, 320, 400, 500, 630, 800, 1 000 and 1 250 A.

**5B.5.5.4** The ratings of rewirable and HRC fuses shall be in accordance with Standard practice [(13) IS 2086].



**ELECTRICAL AND ALLIED INSTALLATIONS**

**5B.5.5.5** The current ratings of miniature circuit-breakers shall be chosen from the values given below:

6,8,10,13,16,20,25,32,40,50,63, 80,100 and125 A.

**5B.5.5.6** The current ratings of moulded case circuit breakers shall be chosen from the values given below:

100,125,160,200,250,315,400,630,800,1 000,1250 and 1600 A.

**5B.5.5.7** The current ratings of air circuit-breakers shall, be chosen from the values given below:

630,800,1 000,1 250,1 600,2 000,2 500,3 200and 4 000 A.

**5B.5.5.8** The current ratings of the distribution fuse board shall be selected from one of the following values:

6,16,25,63 and 100A

**5B.5.6 Installation Circuits**

<i>Type of Circuit</i>	<i>Wire Size</i>	<i>Number of Circuits</i>
Lighting	1.0 mm <sup>2</sup>	2 or more
Socket-outlets 10 A	2.5 mm <sup>2</sup>	Any number Areas such as kitchens and laundries 3x double socket outlets per circuit. Other areas up to12 double socket outlets
Socket-outlets 15 or20 A	2.5 mm <sup>2</sup>	1
Water heater 3 kW	1.5 mm <sup>2</sup>	1
Water heater 3-6 kW	2.5 mm <sup>2</sup>	1
Free standing electric range	6.0 mm <sup>2</sup>	1
Separate oven and/ or cook top	4.0 mm <sup>2</sup>	1
Permanently connected appliances including dish-washers, heaters, etc	2.5 mm <sup>2</sup>	1 above 10 A. Up to 10 A can be wired as part of a socket-outlet circuit
Sub mains to garage or out-building	2.5 mm <sup>2</sup>	1 for each
Mains cable	16 mm <sup>2</sup>	1

## 5B.5.6.1 Selecting and Installing Cables

## 5B.5.6.1.1 Cable insulation types

For the mains cable	Tough plastic sheathed (TPS) cable
For installation wiring	Tough plastic sheathed (TPS) cables
For main earth or main equipotential wire	Polyvinyl chloride (PVC) insulated conduit wire
Underground installation and installation in cable trench, feeders between buildings etc.,	PVC insulated, PVC sheathed armoured cables or XLPE insulated, PVC sheathed cables armoured cables
Installation in plant rooms, switch rooms etc, on cable tray or ladder or protected trench, where risk of mechanical damage to cable does not exist.	PVC insulated, PVC sheathed or XLPE insulated, PVC sheathed unarmoured cable

For the purposes of this Code cables above 1 mm<sup>2</sup> must have stranded conductors. All cables when installed, must be adequately protected against mechanical damage. This can be carried out by either having additional protection, such as being enclosed in PVC conduit or metal pipes, or placing the cables in a suitable location that requires no additional protection. The cables for wiring circuits in electrical installation must have the appropriate wire size matching the requirement of the loads and the following table gives the recommendations for different types of loads.

<i>Circuits</i>	<i>Minimum Wire Size</i>	<i>Wire Colour</i>
1-way lighting	2 + E cable wires 1.5 mm <sup>2</sup>	Brown-Blue-Green or Green/Yellow
2-way lighting control (straps between the 2 switches)	3-wire cable 1.5 mm <sup>2</sup>	Brown –Brown- Blue
Storage water heaters up to 3 kW	2+E cable 1.5mm <sup>2</sup> (stranded conductors)	Brown-Blue-Green or Green/Yellow
Storage water heaters between 3 kW and 6 kW	2 + E cable 2.5 mm <sup>2</sup> (stranded conductors)	Brown-Blue-Green or Green/Yellow
Socket-outlets and permanent and permanent connection units	2 + E cable 2.5 mm <sup>2</sup> (stranded conductors )	Brown-Blue-Green or Green/Yellow
Submains to garages or outbuildings	2 + E cable 2.5 mm <sup>2</sup> (stranded conductors)	Brown-Blue-Green or Green/ Yellow
Cooking hobs	2 + E cable 4 mm <sup>2</sup>	Brown-Blue-Green or Green/Yellow

**ELECTRICAL AND ALLIED INSTALLATIONS**

Separate ovens	2 + E cable 4 mm <sup>2</sup> (stranded conductors)	
Electric range	2 + E cable 6 mm <sup>2</sup> (stranded conductors)	Brown-Blue-Green or Green/Yellow
Mains	2 wire cable 16 mm <sup>2</sup> (stranded conductors)	Brown-Blue
Main equipotential bonding wire	Conduit wire 4 mm <sup>2</sup> (stranded conductors)	Green or Green/Yellow
Main earth wire	Conduit wire 6 mm <sup>2</sup> (stranded conductors)	Green or Green/Yellow

2 + E is also known as twin and earth

**5B.5.6.1.2 Circuit wire sizes**

Switch or isolator controlling a water heater or geyser should not be located within 1m from the location of a shower or bath tub, to avoid a person in wet condition reaching the switch or isolator. It is preferable to provide the control switch outside the bathroom near the entrance and provide an indication at the water heater. A socket or a connector block with suitable protection against water spray should be provided to connect the water heater. The above considerations apply to switches for outdoor lights and other appliances, with the object of avoidance of operation of a switch when a person is wet. Sockets in kitchen, bathroom, toilet, garage etc, should not be provided within a height of 1 m from the ground level. Similar care has to be taken for installations involving fountains, swimming pools etc. Light fittings in such areas should be fed at low voltage, preferably through an isolating transformer with a proper earth leakage protection.

**5B.5.6.2 Requirements for Physical Protection of Underground Cables**

<i>Protective Element</i>	<i>Specifications</i>
Bricks	a) 100mm minimum width b) 25 mm thick c) sand cushioning 100 mm and sand cover 100 mm.
Concrete slabs	at least 50 mm thick.
Plastic slabs(polymeric cover strips ) Fiber reinforced plastic	at least 10 mm thick, depending on properties and has to be matched with the protective cushioning and cover.
PVC conduit or PVC pipe or stoneware pipe or hume pipe	The pipe diameter should be such so that the cable is able to easily slip down the pipe

Galvanized pipe	The pipe diameter should be such so that the cable is able to easily slip down the pipe.
-----------------	--

The trench shall be backfilled to cover the cable initially by 200 mm of fill; and then a plastic marker strip over the full length of cable in the trench. Fill the trench shall be laid before filling the full trench. The marker signs where any cable enters or leaves a building shall be put. This will identify that there is a cable located underground near the building. If the cables rise above ground to enter a building or other structure, a mechanical protection such as a GI pipe or PVC pipe for the cable from the trench depth to a height of 2.0 m above ground shall be provided.

### **5B.5.7 Lighting and Levels of Illumination**

#### **5B.5.7.1 General**

Lighting installation shall take into consideration the many factors on which the quality and quantity of artificial lighting depends. The modern concept is to provide illumination with the help of a large number of light sources not of higher illumination level. Also much higher levels of illumination are called for, than in the past, often necessitating the use of fluorescent lighting suitably supplemented with incandescent fittings, where required.

#### **5B.5.7.2 Future Demand**

However, if for financial reasons, it is not possible to provide a lighting installation to give the recommended illumination levels, the wiring installation at least should be so designed that at a later date, it will permit the provision for additional lighting fittings or conversion from incandescent to fluorescent lighting fittings or high efficient LED light to bring the installation to the required standard. It is essential that adequate provisions should be made for all the electrical services which may be required immediately and during the intended useful life of the building.

#### **5B.5.7.3 Principles of Lighting**

When considering the function of artificial lighting, attention shall be given to the following principle characteristics before designing an installation:

- a) illumination and its uniformity;
- b) special distribution of light. This includes a reference to the composition of diffused and directional light, direction of incidence, the distribution of luminances and the degree of glare; and
- c) colour of the light and colour rendition.

**5B.5.7.4** The variety of purposes which have to be kept in mind while planning the lighting installation could be broadly grouped as:

- a) industrial buildings and processes;
- b) offices, schools and public buildings;
- c) surgeries and hospitals; and
- d) hostels, restaurants, shops and residential buildings.

**5B.5.7.4.1** It is important that appropriate levels of illumination for these and the types and positions of fittings determined to suit the task and the disposition of the working planes.

**5B.5.7.5** For specific requirements for lighting of special occupancies, reference shall be made to Standard practice [(14) IS 2672].

**5B.5.7.6 Energy Conservation**

Energy conservation may be achieved by using the following:

- a) Energy efficient lamps, chokes, ballast, etc for lighting equipment.
- b) Efficient switching systems such as remote sensors, infrared switches, master switches, remote switches, etc for switching ON and OFF of lighting circuits.
- c) Properly made/connected joints/contacts to avoid loose joints leading to loss of power.

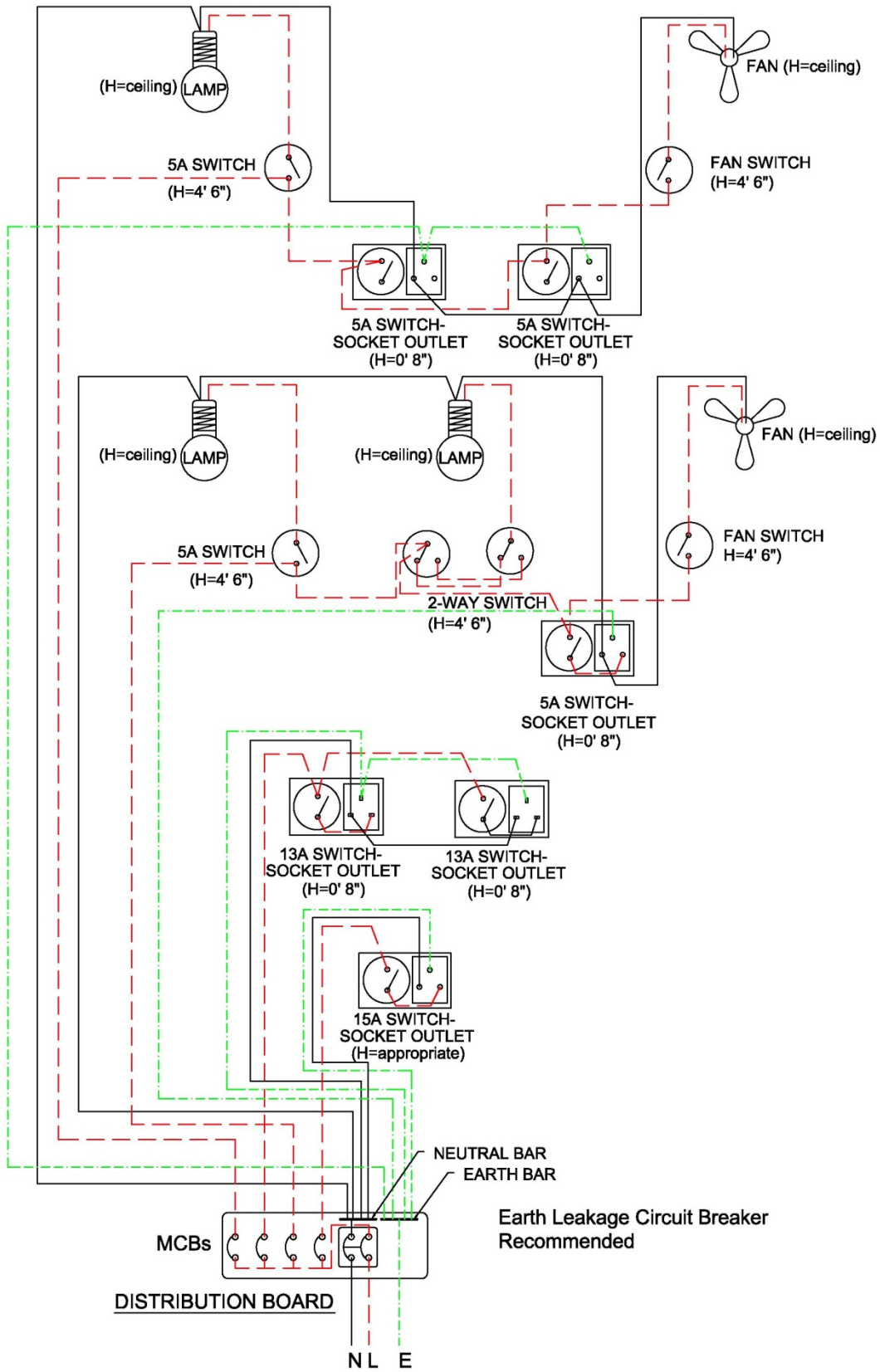

Figure 1: Wiring Diagram for a Typical Distribution Board Scheme in a Residential Building Flat

**5B.5.8** In locations where the system voltage exceeds 650V, as in the case of industrial locations, for details of design and construction of wiring installation, reference may be made to Standard practice [(15) IS 732].

#### **5B.5.9 Guideline for Electrical Layout in Residential Buildings**

For guidelines for electrical installation in residential buildings, reference may be made to Standard practice [(16) IS 4648].

A typical distribution scheme in a residential building with separate circuits for lights and fans and for power appliances is given in Figure 1.

**5B.5.10** For detailed information regarding the installation of different electrical equipments, reference may be made to Standard practice [(17) IS 900].

### **5B.6 WIRING**

#### **5B.6.1 Provision for Maximum Load**

All conductors, switches and accessories shall be of such size as to be capable of carrying, without their respective ratings being exceeded, the maximum current which will normally flow through them.

##### **5B.6.1.1 Estimation of Load Requirements**

In estimating the current to be carried by any conductor the following ratings shall be taken, unless the actual values are known or specified for these elements:

---

<i>Element</i>	<i>Rating (in W)</i>
Incandescent lamps	60
Ceiling fans	} 100
Table fans	
Ordinary socket outlet points	100
Fluorescent tubes:	
Length: 600 mm	25
1 200mm	50
1 500 mm	90
Power socket-outlet	1 000
Air-conditioner	2 500

---

**5B.6.1.2** Electrical installation in a new building shall normally begin immediately on the completion of the main structural building work and before finishing work such as plastering has begun except in the case of surface wiring which can be carried out after the plaster work. Usually, no installation work should start until the building is reasonably weatherproof, but where electric wiring is to be concealed within the structures as may be the case with a reinforced concrete building, the necessary conduits and ducts shall be positioned firmly by tying the conduit to the reinforcement before concreting. When shutters are removed after

concreting, the conduits ends shall be given suitable anti-corrosive treatment and holes blocked off by putties or caps to protect conduits from getting blocked. All conduit openings and junction box openings, etc shall be properly protected against entry of mortar, concrete, etc during construction.

### **5B.6.2 Selection of Size of Conductors**

The size of conductors of circuits shall be so selected that the drop in voltage from consumer's terminals in a public supply (or from the busbars of the main switchboard controlling the various circuits in a private generation plant) to any point on the installation does not exceed four percent of the voltage at the consumer's terminals (or at two busbars as these may be) when the conductors are carrying the maximum current under the normal conditions of service.

**5B.6.2.1** If the cable size is increased to avoid voltage drop in the circuit, the rating of the cable shall be the circuit or sub-circuit the fuse shall be selected to match the cable rating to ensure the desired protection.

### **5B.6.3 Branch Switches**

Where the supply is derived from a three-wire or four wire source, and distribution is done on the two-wire system, all branch switches shall be placed in the outer or live conductor of the circuit and no single phase switch or protective device shall be inserted in the middle wire, earth or earthed neutral conductor of the circuit. Single-pole switches (other than for multiple control) carrying not more than 16 A may be of tumbler type or flush type which shall be on when the handle or knob is down.

### **5B.6.4 Layout and Installation Drawing**

**5B.6.4.1** The electrical layout should be drawn indicating properly the locations of all outlets for lamps, fans, appliances both fixed and transportable, motors, etc, and best suit for wiring.

**5B.6.4.2** All runs of wiring and the exact positions of all points of switch-boxes and other outlets shall be first marked on the plans of the building and approved by the engineer-in-charge or the owner before actual commencement of the work.

**5B.6.4.3** Industrial layout drawings should indicate the relative civil and mechanical details.

#### **5B.6.4.4 Layout of Wiring**

The layout of wiring should be designed keeping in view disposition of the lighting system to meet the illumination levels. All wirings shall be done on the distribution system with main and branch distribution boards at convenient physical and electrical load centres. All types of wiring, whether concealed or unconcealed should be as near the ceiling as possible. In all types of wirings due consideration shall be given for neatness and good appearance.

**5B.6.4.5** Balancing of circuits in three-wire or poly-phase installation shall be arranged before hand. Proper Balancing can be done only under actual load conditions. Conductors shall be so enclosed in earthed metal or incombustible insulating material that it is not possible to have ready access to them. Means of access shall be marked to indicate the voltage present.

Where terminals or other fixed live parts between which a voltage exceeding 250 V exists are housed in separate enclosures or items of apparatus which, although separated are within reach of each other, a notice shall be placed in such a position that anyone gaining access to live parts is warned of the magnitude of the voltage that exists between them.

Where loads are single phase, balancing should be for the peak load condition based on equipment usage. Facility for change should be built into the distribution design.



NOTE — The above requirements apply equally to three-phase circuits in which the voltage between lines or to earth exceeds 250 V and to groups of two or more single-phase circuits, between which medium voltage may be present, derived there from. They apply also to 3-wire dc or 3-wire single-phase ac circuits in which the voltage between lines or to earth exceeds 250 V and to groups of 2-wire circuits, between which medium voltage may be present, derived there from.

**5B.6.4.6** Medium voltage wiring and associated apparatus shall comply, in all respects, with the requirements of Myanmar Electricity Rules.

### **5B.6.5 Conductors and Accessories**

#### **5B.6.5.1 Conductors**

Conductors for all the internal wiring shall be of copper. Conductors for power and lighting circuits shall be of adequate size to carry the designed circuit load without exceeding the permissible thermal limits for the insulation. The conductor for final sub-circuit for fan and light wiring shall have a nominal cross sectional area not less than 1.50 mm<sup>2</sup> copper. The cross-sectional area of conductor for power wiring shall be not less than 4.0 mm<sup>2</sup> copper. The minimum cross sectional area of conductor of flexible cord shall be 1.50 mm<sup>2</sup> copper.

In existing buildings where aluminium wiring has been used for internal electrification, changeover from aluminium conductor to copper conductor may be made once the former goes beyond economical repairs.

NOTE — It is advisable to replace wiring, which is more than 30 years old as the insulation also would have deteriorated, and will be in a state to cause failure on the slightest of mechanical or electrical disturbance.

#### **5B.6.5.2 Flexible Cables and Flexible Cords**

Flexible cables and cords shall be of copper and stranded and protected by flexible conduits or tough rubber or PVC sheath to prevent mechanical damage.

#### **5B.6.5.3 Cable Ends**

When a stranded conductor having a nominal sectional area less than 6 mm<sup>2</sup> is not provided with cable sockets, all strands at the exposed ends of the cable shall be soldered together or crimped using suitable sleeve or ferrules.

#### **5B.6.5.4 Special Risk**

Special forms of construction, such as flameproof enclosures, shall be adopted where there is risk of the fire or explosion

#### **5B.6.5.5 Connection to Ancillary Buildings**

Unless otherwise specified, electric connections to ancillary buildings, such as out-houses, garages, etc, adjacent to the main building and when no roadway intervenes shall be taken in an earthed GI pipe or heavy-duty PVC or HDPE pipe of suitable size in the exposed portion at a height of not less than 5.8 m or by buried underground cables. This applies to both runs of mains or sub-mains or final sub-circuit wiring between the buildings.

#### **5B.6.5.6 Expansion Joints**

Distribution boards shall be so located that the conduits shall not normally be required to cross expansion joints in a building. Where such crossing is found to be unavoidable, special

care shall be taken to ensure that the conduit runs and wiring are not in any way put to strain or damaged due to expansion of building structure. Anyone of the standard methods of connection at a structural expansion joint shall be followed:

- a) Flexible conduit shall be inserted at place of expansion joint.
- b) Oversized conduit overlapping the conduit.
- c) Expansion box.

#### **5B.6.5.7 Low Voltage (Types of Wires/Cables)**

Low voltage services utilize various categories of cables/wires, such as Fibre optic cable, co-axial, etc. These shall be laid at least minimum specified distance of 300 mm from any power wire or cable. Special care shall be taken to ensure that the conduit runs and wiring are laid properly for low voltage signal to flow through it.

#### **5B.6.6 Joints and Looping Back**

**5B.6.6.1** Where looping back system of wiring is specified, the wiring shall be done without any junction or connector boxes on the line. Where joint box system is specified, all joints in conductors shall be made by means of suitable mechanical connectors in suitable joint boxes. Wherever practicable, looping back system should be preferred. Whenever practicable, only one system shall be adopted for a building, preferably a looping back system.

**5B.6.6.2** In any system of wiring, no bare or twist joints shall be made at intermediate points in the through run of cables unless the length of a final sub-circuit, sub-main or main or more than the length of the standard coil as given by the manufacturer of the cable. If any jointing becomes unavoidable such joint shall be made through proper cutouts or through proper junction boxes open to easy inspection, but in looping back system no such junction boxes shall be allowed.

**5B.6.6.3** Joints are a source of problems in reliability and are also vulnerable to fire. They should be avoided or at least minimized. Where joints in cable conductors or bare conductors are necessary, they shall be mechanically and electrically sound. Joints in non-flexible cables shall be accessible for inspection; provided that this requirement shall not apply to joints in cables buried underground, or joints buried or enclosed in non-combustible building materials. Joints in non-flexible cables shall be made by soldering, brazing, welding or mechanical clamps, or be of the compression type; provided that mechanical clamps shall not be used for inaccessible joints buried or enclosed in the building structure. All mechanical clamps and compression type sockets shall securely retain all the wires of the conductors. Any joint in a flexible cable of flexible cord shall be effected by means of a cable coupler.

For flexible cables for small loads less than 1 kW, while it would be desirable to avoid joints, if unavoidable, joints can be made either by splicing by a recognized method or by using a connector and protecting the joint by suitable insulating tape or sleeve or straight joint. For application of flexible cable for loads of 1 kW or more, if joint is unavoidable, crimped joint would be preferred. Spliced joint should not be used for large loads.

There are different standard joints such as epoxy resin based joint, heat shrinkable plastic sleeve joint etc, and each one has its advantage and disadvantage. Selection has to be made on the basis of application, site conditions and availability of skilled licensed workmen.

**5B.6.6.4** Every joint in a cable shall be provided with insulation not less effective than that of the cable cores and shall be protected against moisture and mechanical damage. Soldering

fluxes which remain acidic or corrosive at the completion of the soldering operation shall not be used.

For joints in paper-insulated metal-sheathed cables, a wiped metal sleeve or joint box, filled with insulating compound, shall be provided.

Where an aluminium conductor and a copper conductor are joined together, precautions shall be taken against corrosion and mechanical damage to the conductors.

#### **5B.6.6.5 Pull at Joints and Terminals**

Every connection at a cable termination shall be made by means of a terminal, soldering socket, or compression type socket and shall securely contain and anchor all the wires of the conductor, and shall not impose any appreciable mechanical strain on the terminal or socket.

Flexible cords shall be so connected to devices and to fittings that tension will not be transmitted to joints or terminal screws. This shall be accomplished by a knot in the cord, by winding with tape, by a special fitting designed for that purpose, or by other approved means which will prevent a pull on the cord from being directly transmitted to joints or terminal screws.

#### **5B.6.7 Passing Through Walls and Floors**

**5B.6.7.1** Where conductors pass through walls, one of the following methods shall be employed. Care shall be taken to see that wires pass freely through protective pipe or box and that the wires pass through in a straight-line without any twist or cross in wires on either ends of such holes:

- a) The conductor shall be carried either in a rigid steel conduit or a rigid non-metallic conduit conforming to accepted standards [(19) IS 2667].
- b) *Conduit colour coding*

The conduits shall be colour coded as per the purpose of wire carried in the same. The colour coding may be in form of bands of colour (4 inch thick, with centre-to-centre distance of 12 inches) or coloured throughout in the colour. The colour scheme shall be as follows:

<i>Conduit Type</i>	<i>Colour Scheme</i>
Power conduit	Black
Security conduit	Blue
Fire alarm conduit	Red
Low voltage conduit	Brown
UPS conduit	Green

- c) *Cable trunking/cable ways*

For the smaller cables, enclosures such as conduit and trunking, may be employed and PVC-insulated, with or without sheath, single core cables installed following completion of the conduit/trunking system. As these cables are usually installed in relatively large groups, care must be taken to avoid overheating and to provide identification of the different circuits.

- d) *Tray and ladder rack*

## ELECTRICAL AND ALLIED INSTALLATIONS

As tray provides continuous support, unless mounted on edge or in vertical runs (when adequate strapping or clipping is essential), the mechanical strength of supported cable is not as important as with ladder-racking or structural support methods. Consequently, tray is eminently suitable for the smaller unarmoured cabling while racks and structural support, except for short lengths, call for armoured cables as they provide the necessary strength to avoid sagging between supports. Both tray and ladder racks can be provided with accessories to facilitate changes of route, and as PVC and similar insulating materials are non-migratory (unlike the older types of impregnated cables) they provide no difficulty in this respect on vertical runs.

Insulated conductors while passing through floors shall be protected from mechanical injury by means of rigid steel conduit, non-metal conduit or mechanical protection to a height not less than 1.5 m above the floors and flush with the ceiling below. This steel conduit shall be earthed and securely bushed. Power outlets and wiring in the floor shall be generally avoided. If not avoidable, use false floor or floor trunking. False floor shall be provided where density of equipment and interconnection between different pieces of equipment is high. Examples are: Mainframe Computer station, Telecommunication switch rooms, etc.

Floor trunking shall be used in large halls, convention centres, open plan offices, laboratory, etc.

In case of floor trunking drain points shall be provided, as there could be possibility of water seepage in the case of wiring passing through the floors. Proper care should be taken for suitable means of draining of water. Possibility of water entry exists from: (1) floor washing, (2) condensation in some particular weather and indoor temperature conditions. At the design stage, these aspects have to be assessed and an appropriate means of avoiding, or reducing, and draining method will have to be built in.

Floor outlet boxes are generally provided for the use of appliances, which require a signal, or communication connection. The floor box and trunking system should cater to serve both power distribution and the signal distribution, with appropriate safety and non-interference.

**5B.6.7.2** Where a wall tube passes outside a building so as to be exposed to weather, the outer end shall be bell-mouthed and turned downwards and properly bushed on the open end.

### **5B.6.8 Wiring of Distribution Boards**

**5B.6.8.1** All connections between pieces of apparatus or between apparatus and terminals on a board shall be neatly arranged in a definite sequence, following the arrangements of the apparatus mounted thereon, avoiding unnecessary crossings.

**5B.6.8.2** Cables shall be connected to a terminal only by soldered or welded or crimped lugs using suitable sleeve, lugs or ferrules unless the terminal is of such a form that it is possible to securely clamp them without the cutting away of cables stands. Cables in each circuit shall be bunched together.

**5B.6.8.3** All bare conductors shall be rigidly fixed in such a manner that a clearance of at least 25 mm is maintained between conductors or opposite polarity or phase and between the conductors and any material other than insulation material.

**5B.6.8.4** If required, a pilot lamp shall be fixed and connected through an independent single pole switch and fuse to the bus-bars of the board.

**5B.6.8.5** In a hinged type board, the incoming and outgoing cables shall be fixed at one or more points according to the number of cables on the back of the board leaving suitable space in between cables, and shall also, if possible, be fixed at the corresponding points on the

switchboard panel. The cables between these points shall be of such length as to allow the switchboard panel to swing through on angle of not less than 90°. The circuit breakers in such cases shall be accessible without opening the door of distribution board. Also, circuit breakers or any other equipment (having cable size more than 1.5 sq. mm multi strand wire) shall not be mounted on the door.

NOTE — Use of hinged type boards is discouraged, as these boards lead to deterioration of the cables in the hinged portion, leading to failures or even fire.

**5B.6.8.6** Wires terminating and originating from the protective devices shall be properly lugged and taped.

### **5B.6.9 PVC-Sheathed Wiring System**

#### **5B.6.9.1 General**

Wiring with Tough Rubber-Sheathed (TRS) cables had been the common system for low voltage installations. Now TRS wiring is phased out as better and durable insulating materials are available.

Wiring with PVC-sheathed cables is suitable for medium voltage installation and may be installed directly under exposed conditions of sun and rain or damp places.

#### **5B.6.9.2 PVC Clamps/PVC Channel**

Link clips had been the common system for wiring on wooden batten, which is now phased out. PVC clamps/PVC channel shall conform accepted standards. The clamps shall be used for temporary installations of 1-3 sheathed wires only. The clamps shall be fixed on wall at intervals of 100 mm in the case of horizontal runs and 150 mm in the case of vertical runs.

PVC channel shall be used for temporary installations in case more than 3 wires or wires or unsheathed wires. The channel shall be clamped on wall at intervals not exceeding 300 mm.

#### **5B.6.9.3 Protection of PVC-Sheathed Wiring from Mechanical Damage**

- a) In cases where there are chances of any damage to the wirings, such wirings shall be covered with sheet metal protective covering, the base of which is made flush with the plaster or brickwork, as the case may be, or the wiring shall be drawn through a conduit complying with all requirements of conduit wiring system (see 6.10).
- b) Such protective coverings shall in all cases be fitted on all down-drops within 1.5 m from the floor.

#### **5B.6.9.4 Bends in Wiring**

The wiring shall not in any circumstances be bent so as to form a right angle but shall be rounded off at the corners to a radius not less than six times the overall diameter of the cable.

#### **5B.6.9.5 Passing Through Floors**

All cables taken through floors shall be enclosed in an insulated heavy gauge steel conduit extending 1.5 m above the floor and flush with the ceiling below, or by means of any other approved type of metallic covering. The ends of all conduits or pipes shall be neatly bushed with porcelain, wood or the approved material.

#### **5B.6.9.6 Passing Through Walls**

The method to be adopted shall be according to good practice. There shall be one or more conduits of adequate size to carry the conductors [see **5B.6.10.1(a)**]. The conduits shall be neatly arranged so that the cables enter them straight without bending.

#### **5B.6.9.7 Stripping of Outer Covering**

While cutting and stripping of the outer covering of the cables, care shall be taken that the sharp edge of the cutting instrument does not touch the rubber or PVC-sheathed insulation of conductors. The protective outer covering of the cables shall be stripped off near connecting terminals, and this protective covering shall be maintained up to the close proximity of connecting terminals as far as practicable. Care shall be taken to avoid hammering on link clips with any metal instruments, after the cables are laid. Where junction boxes are provided, they shall be made moisture-proof with an approved plastic compound.

#### **5B.6.9.8 Painting**

If so required, the tough rubber-sheathed wiring shall, after erection, be painted with one coat of oil-less paint or distemper of suitable colour over a coat of oil-less primer, and the PVC-sheathed wiring shall be painted with a synthetic enamel paint of quick drying type.

### **5B.6.10 Conduit Wiring System**

#### **5B.6.10.1 Surface Conduit Wiring System with Rigid Steel Conduits**

- a) *Type and size of conduit*— All conduit pipes shall conform to accepted standards [(19) IS 2667], finished with galvanized or stove enameled surface. All conduit accessories shall be of threaded type and under no circumstance pin grip type or clamp type accessories be used. No steel conduit less than 16 mm in diameter shall be used. The number of insulated conductors that can be drawn into rigid conduit are given in Tables 1 and 2.
- b) *Bunching of cables*— Unless otherwise specified, insulated conductors of ac supply and dc supply shall be bunched in separate conduits. For lighting and small power outlet circuits phase segregation in separate conduits is recommended.
- c) *Conduit joints*— Conduit pipes shall be joined by means of screwed couplers and screwed accessories only [(19) IS 2667]. In long distance straight runs of conduit, inspection type couplers at reasonable intervals shall be provided or running threads with couplers and jam-nuts (in the latter case the bare threaded portion shall be treated with anti-corrosive preservative) shall be provided. Threaded on conduit pipes in all cases shall be between 11 mm to 27 mm long sufficient to accommodate pipes to full threaded portion of couplers or accessories. Cut ends of conduit pipes shall have no sharp edges nor any burrs left to avoid damage to the insulation of conductors while pulling them through such pipes.
- d) *Protection against dampness*— In order to minimize condensation or sweating inside the tube, all outlets of conduit system shall be properly drained and ventilated, but in such a manner as to prevent the entry of insects as far as possible.
- e) *Protection of conduit against rust*— The outer surface of the conduit pipes, including all bends, unions, tees, conduit system shall be adequately protected against rust particularly when such system is exposed to weather. In all cases, no bare threaded portion of conduit pipe shall be allowed unless such bare threaded portion is treated with anti-corrosive preservative or covered with suitable plastic compound.



**ELECTRICAL AND ALLIED INSTALLATIONS**

16	7/1.70	-	-	-	-	2	-	4	3	7	6	-	-	-	-
25	7/2.24	-	-	-	-	-	-	3	2	5	4	8	6	9	7
35	7/2.50	-	-	-	-	-	-	2	-	4	3	7	5	8	6
50	19/1.80														

**NOTES**

**1** The table shows the maximum capacity of conduits for the simultaneously drawing of cables. The columns headed S apply to runs of conduit which have distance not exceeding 4.25 m between draw-in boxes, and which do not deflect from the straight by an angle of more than 15°. The columns headed B apply to runs of conduit which deflect from the straight by an angle of more than 15°.

**2** In case an inspection type draw-in box has been provide and if first drawn through on straight conduit, then through the draw in box, and then through the second straight conduit, such systems may be considered as that of a straight conduit even if the conduit deflects through the straight by more than 15°

<sup>1)</sup> For copper conductor only.

- f) *Fixing of conduit*— Conduit pipes shall be fixed by heavy gauge saddles, secured to suitable wood plugs or other plugs with screws in an approved manner at an interval in an approved manner at an interval of not more than 1 m, but on either side of couplers or bends or similar fittings, saddles shall be fixed at a distance of 300 cm from the centre of such fittings.
- g) *Bends in conduit*— All necessary bends in the system including diversion shall be done by bending pipes; solid or inspection type normal bends, elbows or similar fittings; or fixing cast iron, thermoplastic or thermosetting plastic material inspection boxes whichever is more suitable. Conduit fittings shall be avoided as far as possible on conduit system exposed to weather; where necessary, solid type fittings shall be used. Radius of such bends in conduit pipes shall be not less than 7.5 cm. No length of conduit shall have more than the equivalent of four quarter bends from outlet to outlet, the bends at the outlets not being counted,
- h) *Outlets*— All outlets for fittings, switches, etc, shall be boxes of suitable metal or any other approved outlet boxes for either surface mounting system.



Table 2: Maximum Permissible Number of Single-Core Cables that can be Drawn into Cable Tunneling/Trunking and Ducting System (Casing and Capping)

(Clauses 5B.6.10.1 and 5B.6.10.3.2)

Norminal Cross- Sectional Area of Conductor in mm <sup>2</sup>	10/15mm x 10mm	20mm x 10mm	25mm x 10mm	30mm x 10mm	40mm x 20mm	50mm x 20mm
(1)	(2)	(3)	(4)	(5)	(6)	(7)
1.5	3	5	6	8	12	18
2.5	2	4	5	6	9	15
4	2	3	4	5	8	12
6	-	2	3	4	6	9
10	-	1	2	3	5	8
16	-	-	1	2	4	6
25	-	-	-	1	3	5
35	-	-	-	-	2	4
50	-	-	-	-	1	3
70	-	-	-	-	1	2

## ELECTRICAL AND ALLIED INSTALLATIONS

- i) *Conductors*— All conductors used in conduit wiring shall preferably be stranded. No single-core cable of nominal cross-sectional area greater than 130 mm<sup>2</sup> enclosed along in a conduit and used for alternating current,
- j) *Erection and earthing of conduit*— The conduit of each circuit or section shall be completed before conductors are drawn in. The entire system of conduit after erection shall be tested for mechanical and electrical continuity throughout and permanently connected to earth conforming to the requirements as already specified by means of suitable earthing clamp efficiently fastened to conduit pipe in a workman like manner for a perfect continuity between each wire and conduit. Gas or water pipes shall not be used as earth medium. If conduit pipes are liable to mechanical damage they shall be adequately protected.
- k) Inspection type conduit fittings, such as inspection boxes, draw boxes, bends, elbows and tees shall be so installed that they can remain accessible for such purposes as to withdrawal of existing cables or the installing of traditional cables.

### 5B.6.10.2 Recessed Conduit Wiring System with Rigid Steel Conduit

Recessed conduit wiring system shall comply with the requirements for surface conduit wiring system specified in **5B.6.10.1 (a) to (k)** and in addition, conform to the requirements specified below:

- a) *Making of chase*— The chase in the wall shall be nearly made and be of ample dimensions to permit the conduit to be fixed in the manner desired. In the case of buildings under construction, chases shall be provided. In the wall, ceiling, etc, at the time of their construction and shall be filled up neatly after reaction of conduit and brought to the original finish of the wall. In case of exposed brick/rubble masonry work, special care shall be taken to fix the conduit and accessories in position along with the building work.
- b) *Fixing of conduit in chase*— The conduit pipe shall be fixed by means of staples or by means of saddles not more than 600 mm apart. Fixing of standard bends or elbows shall be avoided as far as practicable and all curves maintained by bending the conduit pipe itself with a long radius which will permit easy drawing-in of conductors. All threaded joints of rigid steel conduit shall be treated with preservative compound to secure protection against rust.
- c) *Inspection boxes*— Suitable inspection boxes shall be provided to permit periodical inspection and to facilitate removal of wires, if necessary. These shall be mounted flush with the wall. Suitable ventilating holes shall be provided in the inspection box covers. The minimum sizes of inspection boxes shall be 75 mm x 75 mm.
- d) *Types of accessories to be used*— All outlet, such as switches and wall sockets, may be either of flush mounting type or of surface mounting type.
  - 1) *Flush mounting type*— All flush mounting outlets shall be of cast-iron or mild steel boxes with a cover of insulating material or shall be a box made of a suitable insulating material. The switches and other outlets shall be mounted on such boxes. The metal box shall be efficiently earthed with conduit by a suitable means of earth attachment.
  - 2) The switches/socket outlets shall be adequately rated IP for various utilizations.

- 3) *Surface mounting type*— If surface mounting type outlet box is specified, it shall be of any suitable insulating material and outlets mounted in an approved manner.

### **5B.6.10.3 Conduit Wiring System with Rigid Non-Metallic Conduits**

Rigid non-metallic conduits are used for surface, recessed and concealed conduit wiring. Cable trunking and ducting system of insulating material are used for surface wiring.

#### **5B.6.10.3.1 Type and size**

All non-metallic conduits used shall conform to accepted standards [(19) IS 2667]. The conduit may be either threaded type or plain type in accordance with accepted standards [(19) IS 2667] and shall be used with the corresponding accessories. The conduits shall be circular or rectangular cross-sections.

#### **5B.6.10.3.2 Bunching of cables**

Conductors of ac supply and dc supply shall be bunched in separate conduits. For lighting and small power outlet circuits phase segregation in separate circuits is recommended. The number of insulated cables that may be drawn into the conduits are given in **Table 1** and **Table 2**. In these tables the space factor does not exceed 40 percent.

#### **5B.6.10.3.3 Conduit joints**

Conduits shall be joined by means of screwed or plain couplers depending on whether the conduits are screwed or plain. Where there are long runs of straight conduit, inspection type couplers shall be provided at intervals. For conduit fittings and accessories reference may be made to the Standard practice [(19) IS 2667].

#### **5B.6.10.3.4 Fixing of conduits**

The provisions of **5B.6.10.1(f)** shall apply except that the spacing between saddles or supports is recommended to be 600 cm for rigid non-metallic conduits.

#### **5B.6.10.3.5 Bends in conduits**

Wherever necessary, bends or diversions may be achieved by bending the conduits (*see 5B.6.10.3.8*) or by employing normal bends, inspection bends, inspection boxes, elbows or similar fittings.

**5B.6.10.3.6** Conduit fittings shall be avoided, as far as possible, on outdoor systems

#### **5B.6.10.3.7 Outlets**

In order to minimize condensation or sweating inside the conduit, all outlets of conduit system shall be properly drained and ventilated, but in such a manner as to prevent the entry of insects.

**5B.6.10.3.8** Heat may be used to soften the conduit for bending and forming joints in case of plain conduits. As the material softens when heated, sitting of conduit in close

## ELECTRICAL AND ALLIED INSTALLATIONS

proximity to hot surfaces should be avoided. Caution should be exercised in the use of this conduit in locations where the ambient temperature is 50°C or above. Use of such conduits in places where ambient temperature is 60°C or above is prohibited.

**5B.6.10.3.9** Non-metallic conduit systems shall be used only where it is ensured that they are:

- a) suitable for the extremes of ambient temperature to which they are likely to be subjected in service,
- b) resistant to moisture and chemical atmospheres, and
- c) resistant to low temperature and sunlight effects.

For use underground, the material shall be resistant to moisture and corrosive agents.

NOTE — Rigid PVC conduits are not suitable for use where the normal working temperature of the conduits and fittings may exceed 55°C. Certain types of rigid PVC conduits and their associated fittings are unsuitable for use where the ambient temperature is likely to fall below -5°C.

### **5B.6.10.4 Non-Metallic Recessed Conduit Wiring System**

**5B.6.10.4.1** Recessed non-metallic conduit wiring system shall comply with all the requirements of surface nonmetallic conduit wiring system specified in **5B.6.10.3.1** to **5B.6.10.3.9** except **5B.6.10.3.4**. In addition, the following requirements **5B.6.10.4.2** to **5B.6.10.4.5** also shall be complied with.

#### **5B.6.10.4.2 Fixing of conduit in chase**

The conduit pipe shall be fixed by means of staples or by means of non-metallic saddles placed at not more than 80 cm apart or by any other approved means of fixing. Fixing of standard bends or elbows shall be avoided as far as practicable and all curves shall be maintained by sending the conduit pipe itself with along radius which will permit easy drawing in of conductors. At either side of bends, saddles/staples shall be fixed at a distance of 15 cm from the centre of bends.

#### **5B.6.10.4.3 Inspection boxes**

Suitable inspection boxes to the nearest minimum requirements shall be provided to permit periodical inspection and to facilitate replacement of wires, if necessary. The inspection/junction boxes shall be mounted flush with the wall or ceiling concrete. Where necessary deeper boxes of suitable dimensions shall be used. Suitable ventilating holes shall be provided in the inspection box covers, where required.

**5B.6.10.4.4** The outlet boxes such as switch boxes, regulator boxes and their phenolic laminated sheet covers shall be as per requirements of **5B.6.10.1(h)**,

They shall be mounted flush with the wall.

#### **5B.6.10.4.5 Types of accessories to be used**

All outlets such as switches, wall sockets, etc, maybe either flush mounting type or of surface mounting type.

## **5B.7 FITTINGS AND ACCESSORIES**

### **5B.7.1 Ceiling Roses and Similar Attachments**

**5B.7.1.1** A ceiling rose or any other similar attachment shall not be used on a circuit the voltage of which normally exceeds 250 V.

**5B.7.1.2** Normally, only one flexible cord shall be attached to a ceiling rose. Specially designed ceiling roses shall be used for multiple pendants.

**5B.7.1.3** A ceiling rose shall not embody fuse terminal as an integral part of it.

#### **5B.7.2 Socket-Outlets and Plugs**

Each 16A socket-outlet provided in buildings for the use of domestic appliances such as air conditioner, water cooler, etc, shall be provided with its own individual fuse, with suitable discrimination with backup fuse or miniature circuit-breaker provided in the distribution/sub-distribution board. The socket-outlet shall not necessarily embody the fuse as an integral part of it.

**5B.7.2.1** Each socket-outlet shall also be controlled by a switch which shall preferably be located immediately adjacent thereto or combined therewith.

**5B.7.2.2** The switch controlling the socket-outlet shall be on the live side of the line.

**5B.7.2.3** Ordinary socket-outlet may be fixed at any convenient place at a height above 20 cm from the floor level and shall be away from danger of mechanical injury.

NOTE — In situations where a socket-outlet is accessible to children, it is necessary to install an interlocked plug and socket or alternatively a socket-outlet which automatically gets screened by the withdrawal of plug. In industrial premises socket-outlet of rating 20 A and above shall preferably be provided with interlocked type switch.

**5B.7.2.4** In an earthed system of supply, a socket-outlet with plug shall be of three-pin type with the third terminal connected to the earth. When such socket outlets with plugs are connected to any current consuming device of metal or any non-insulating material or both, conductors connecting such current consuming devices shall be of flexible cord with an earthing core and the earthing core shall be secured by connecting between the earth terminal of plug and the body of current-consuming devices.

In industrial premises three-phase and neutral socket-outlets shall be provided with a earth terminal either of pin type or scrapping type in addition to the main pins required for the purpose.

**5B.7.2.5** In wiring installations, metal clad switch, socket outlet metal clad switch, socket outlet and plugs shall be used for power wiring.

NOTE —A recommended schedule of socket-outlets in a residential building is given below:

<i>Location</i>	<i>Number of 5A Socket-Outlets</i>	<i>Number of 15A Socket-Outlets</i>
Bed room	2 to 3	1
Living room	2 to 3	2

**ELECTRICAL AND ALLIED INSTALLATIONS**

Kitchen	1	2
Dining room	2	1
Garage	1	1
For refrigerator	-	1
For air conditioner	-	(one for each)
<i>VERANDAH</i>	1 per 10m <sup>2</sup>	1
Bathroom	1	1

**5B.7.3 Lighting Fittings**

**5B.7.3.1** A switch shall be provided for control of every lighting fitting or a group of lighting fittings. Where control at more than one point is necessary as many two way or intermediate switches may be provided as there are control points.

**5B.7.3.2** In industrial premises lighting fittings shall be supported by suitable pipe/conduits, brackets fabricated from structural steel, steel chains or similar materials depending upon the type and weight of the fittings. Where a lighting fitting is supported by one or more flexible cords, the maximum weight to which the twin flexible cords may be subjected shall be as follows:

<i>Nominal Cross-Sectional Area of Twin Cord</i>	<i>Maximum Permissible Weight</i>
mm <sup>2</sup>	kg
0.5	2
0.75	3
1.0	5
1.5	5.3
2.5	8.8
4	14.0

**5B.7.3.3** No flammable shade shall form a part of lighting fittings unless such shade is well protected against all risks of fire. Celluloid shade or lighting fittings shall not be used under any circumstances.

**5B.7.3.4** General and safety requirements for electrical lighting fittings shall be in accordance with Standard practice [(20) IS 1913].

**5B.7.3.5** The lighting fittings shall conform to accepted standards [(10) IS 1777].

#### **5B.7.4 Fitting-Wire**

The use of fittings-wire shall be restricted to the internal wiring of the lighting fittings. Where fittings-wire is used for wiring fittings, the sub-circuit loads shall terminate in a ceiling rose or box with connectors from which they shall be carried into the fittings.

#### **5B.7.5 Lampholders**

Lampholders for use on brackets and the like shall be in accordance with accepted standards [(21) IS 1258] and all those for use with flexible pendants shall be provided with cord grips. All lampholders shall be provided with shade carriers. Where centre-contact Edison screw lampholders are used, the outer or screw contacts shall be connected to the 'middle wire', the neutral, the earthed conductor of the circuit.

#### **5B.7.6 Outdoor Lamps**

External and road lamps shall have weatherproof fittings of approved design so as to effectively prevent the ingress of moisture and dust. Flexible cord and cord grip lampholders shall not be used where exposed to weather. In VERANDAHS and similar exposed situations where pendants are used, these shall be of fixed rod type.

#### **5B.7.7 Lamps**

All lamps unless otherwise required and suitably protected, shall be hung at a height of not less than 2.5 m above the floor level. All electric lamps and accessories shall conform to accepted standards [(22) IS 418]

- a) Portable lamps shall be wired with flexible cord. Hand lamps shall be equipped with a handle of moulded composition or other material approved for the purpose. Hand lamps shall be equipped with a substantial guard attached to the lampholder or handle. Metallic guards shall be earthed suitably.
- b) A bushing or the equivalent shall be provided where flexible cord enters the base or stem of portable lamp. The bushing shall be of insulating material unless a jacketed type of cord is used.
- c) All wiring shall be free from short-circuits and shall be tested for these defects prior to being connected to the circuit.
- d) Exposed live parts within porcelain fixtures shall be suitably recessed and so located as to make it improbable that wires will come in contact with them. There shall be a spacing of at least 125 mm between live parts and the mounting plane of the fixture.

#### **5B.7.8 Fans, Regulators and Clamps**

##### **5B.7.8.1 Ceiling Fans**

Ceiling fans including their suspension shall conform to accepted standards [(23) IS 374] and to the following requirements:

## ELECTRICAL AND ALLIED INSTALLATIONS

- a) Control of a ceiling fan shall be through its own regulator as well as a switch in series.
- b) All ceiling fans shall be wired with normal wiring to ceiling roses or to special connector boxes to which fan rod wires shall be connected and suspended from hooks or shackles with insulators between hooks and suspension rods. There shall be no joint in the suspension rod, but if joints are unavoidable then such joints shall be screwed to special couplers of 5 cm minimum length and both ends of the pipes shall touch together within the couplers, and shall in addition be secured by means of split pins; alternatively, the two pipes may be welded. The suspension rod shall be of adequate strength to withstand the dead and impact forces imposed on it. Suspension rods should preferably be procured along with the fan.
- c) Fan clamps shall be of suitable design according to the nature of construction of ceiling on which these clamps are to be fitted. In all cases fan clamps shall be fabricated from new metal of suitable sizes and they shall be as close fitting as possible. Fan clamps for reinforced concrete roofs shall be buried with the casting and due care shall be taken that they shall serve the purpose. Fan clamps for wooden beams, shall be of suitable flat iron fixed on two sides of the beam and according to the size and section of the beam one or two mild steel bolts passing through the beam shall hold both flat irons together. Fan clamps for steel joist shall be fabricated from flat iron to fit rigidly to the bottom flange of the beam. Care shall be taken during fabrication that the metal does not crack while hammer to shape. Other fan clamps shall be made to suit the position, but in all cases care shall be taken to see that they are rigid and safe.
- d) Canopies on top and bottom of suspension rods shall effectively conceal suspensions and connections to fan motors, respectively.



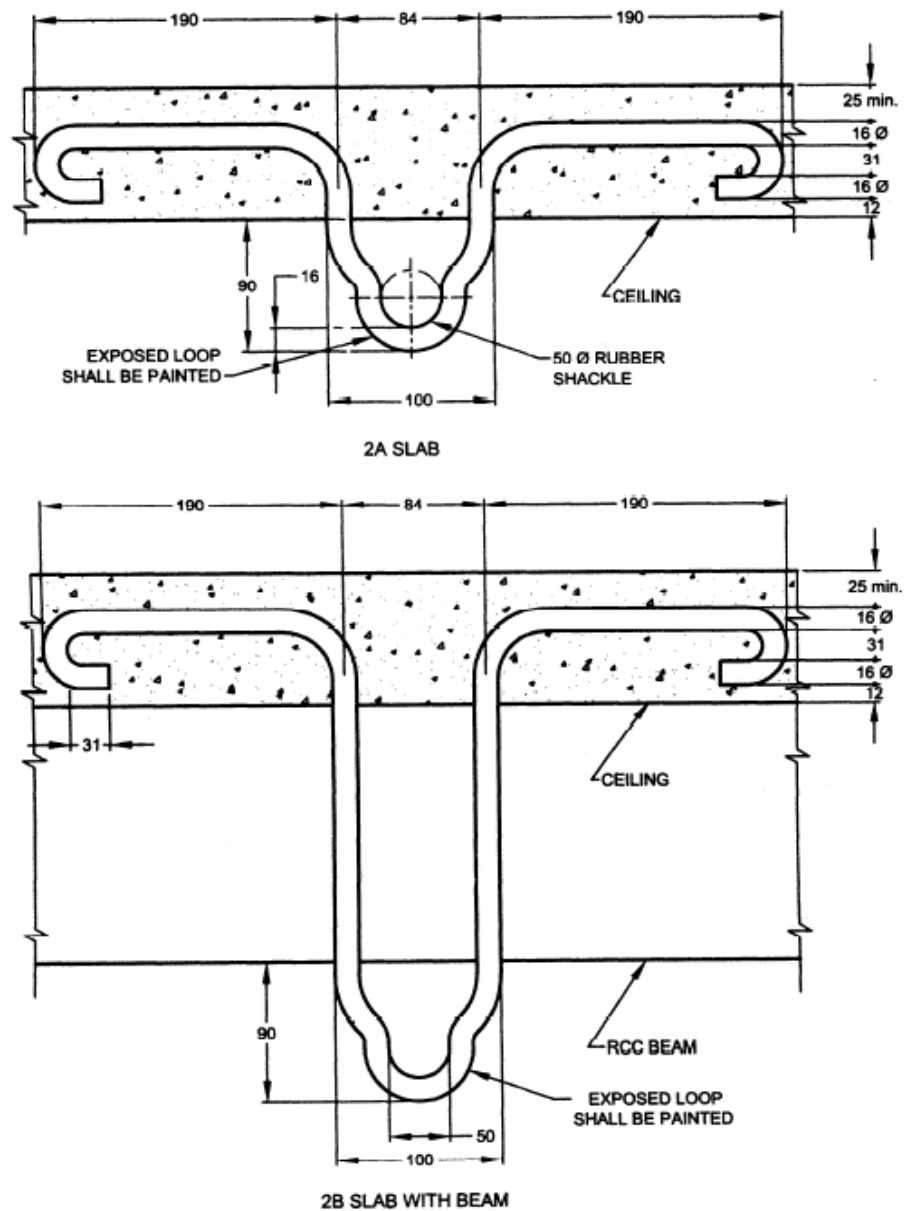

All dimensions in millimetres

#### NOTES

- 1) RCC slab steel reinforcement not shown.
- 2) Fan clamp shall be placed in position such that its projecting arms in the line of length of beam.

Figure 2: Typical Design of Fan Clamps

- e) The lead-in-wire shall be of nominal cross sectional area not less than  $1.5 \text{ mm}^2$  copper and shall be protected from abrasion.
- f) Unless otherwise specified, the clearance between the bottom most point of the ceiling fan and the floor shall be not less than 2.4 m. The minimum clearance between the ceiling and the plane of the blades shall be not less than 300 mm.

A typical arrangement of a fan clamp is given in Figure 2.

NOTE – All fan clamps shall be so fabricated that fans revolve steadily.

#### **5B.7.8.2 Exhaust fans**

For fixing of an exhaust fan, a circular hole shall be provided in the wall to suit the size of the frame which shall be fixed by means of rag-bolts embedded in the wall. The hole shall be nearly plastered with cement and brought to the original finish of the wall. The exhaust fan shall be connected to exhaust fan point which shall be wired as near to the hole as possible by means of a flexible cord, care being taken that the blades rotate in the proper direction.

#### **5B.7.9 Attachment of Fittings and Accessories**

**5B.7.9.1** In wiring other than conduit wiring, all ceiling roses, brackets, pendants and accessories attached to walls or ceilings shall be mounted on substantial teak wood blocks twice varnished after all fixing holes are made in them. Blocks shall not be less than 4 cm deep. Brass screws shall only be used for attaching fittings and accessories to their base blocks.

**5B.7.9.2** Where teak or hardwood boards are used for mounting switches, regulators, etc, these boards shall be well varnished with pure shellac on all four sides (both inside and outside), irrespective of being painted to match the surroundings. The size of such boards shall depend on the number of accessories that could conveniently and neatly be arranged. Where there is danger of attack by white ants, the boards shall be treated with suitable anti-termite compound and painted on both sides.

#### **5B.7.10 Interchangeability**

Similar part of all switches, lampholders, distribution fuse-boards, ceiling roses, brackets, pendants, fans and all other fittings shall be so chosen that they are of the same type and interchangeable in each installation.

#### **5B.7.11 Equipment**

Electrical equipment which form integral part of wiring intended for switching or control or protection of wiring installations shall conform to the relevant Standards wherever they exist.

#### **5B.7.12 Fannage**

**5B.7.12.1** Where ceiling fans are provided, the bay sizes of a building, which control fan point locations, play an important part.

**5B.7.12.2** Fans normally cover an area of 9 m<sup>2</sup> to 10 m<sup>2</sup> and therefore in general purpose office buildings, for every part of a bay to be served by the ceiling fans, it is necessary that the bays shall be so designed that full number of fans could be suitably located for the bay, otherwise it will result in ill-ventilated pockets. In general, fans in long halls may be spaced at 3 m in both the directions. If building modules do not lend themselves for proper positioning of the required number of ceiling fans, such as air circulators or bracket fans would have to be employed for the areas uncovered by the ceiling fans. For this, suitable electrical outlets shall be provided although result will be disproportionate to cost on account of fans.

**5B.7.12.3** Proper air circulation could be achieved either by larger number of smaller fans or smaller number of larger fans. The economics of the system as a whole should be a guiding factor in choosing the number and type of fans and their locations.

**5B.7.12.4** Exhaust fans are necessary for spaces, such as community toilets, kitchens and canteens, and go downs to provide the required number of air changes.

**5B.7.12.5** Positioning of fans and light fittings shall be chosen to make these effective without causing shadows and stroboscopic effect on the working planes.

## **5B.8 EARTHING**

### **5B.8.1 General**

Earthing shall generally be carried out in accordance with the requirements of Myanmar Electricity Rules.

The main earthing system of an electrical installation must consist of:

- a) An earth electrode;
- b) A main earthing wire;
- c) An earth bar (located on the main switchboard) for the connection of the main earthing wire, protective earthing wires and/or bonding wires within the installation; and
- d) A removable link, which effectively disconnects the neutral bar from the earth bar.

NOTE — The requirements of (c) and (d) above must be carried out by the licensed electrician as part of the switchboard installation.

The main earthing wire termination must be readily accessible at the earth electrode.

The main earthing wire connection must:

- a) be mechanically and electrically sound;
- b) be protected against damage, corrosion, and vibration;
- c) not place any strain on the various parts of the connection;
- d) not damage the wire or fittings; and
- e) be secured at the earth electrode

Use a permanent fitting (like a screwed-down plastic label or copper label, or one that can be threaded onto the cable) at the connection point that is clearly marked with the words: "EARTHING LEAD — DO NOT DISCONNECT" or "EARTHING CONDUCTOR —DO NOT DISCONNECT".

**5B.8.1.1** All medium voltage equipment shall be earthed by two separate and distinct connections with earth.

Medium voltage systems of 400/230 V, 4-wire, 3-phase, systems are normally operated with the neutral solidly earthed at source. At medium voltage, Myanmar Electricity Regulations require that the neutral be earthed by two separate and distinct connections with earth. Source in the case of a substation (such as 11kV/400 V) would be the neutral(s) of the transformer(s). Neutral conductor of half the size of the phase conductor was permitted in earlier installations. But with the proliferation of equipment using non-linear devices and consequent increase in harmonics, the neutral will carry a current more than the notional out- of-balance current and as such neutral conductor shall be of the same size as the phase conductor.

In the case of high and extra high voltages, the neutral points shall be earthed by not less than two separate and distinct connections with earth, each having its own electrode at the generating station or substation and may be earthed at any other point provided no interference is caused by such earthing. The neutral may be earthed through suitable

impedance. Neutral earthing conductor shall be sized at to have a current carrying capacity not less than the phase current.

**5B.8.1.2** As far as possible, all earth connections shall be visible for inspection.

**5B.8.1.3** Earth system shall be so devised that the testing of individual earth electrode is possible. It is recommended that the value of any earth system resistance shall be such as to conform with the degree of shock protection desired.

**5B.8.1.4** It is recommended that a drawing showing the main earth connection and earth electrodes be prepared for each installation.

**5B.8.1.5** No addition to the current-carrying system, either temporary or permanent, shall be made which will increase the maximum available earth fault current or its duration until it has been ascertained that the existing arrangement of earth electrodes, earth busbar, etc, are capable of carrying the new value of earth fault current which may be obtained by this addition.

**5B.8.1.6** No cut-out, link or switch other than a linked switch arranged to operate simultaneously on the earthed or earthed neutral conductor and the live conductors, shall be inserted on any supply system. This, however, does not include the case of a switch for use in controlling a generator or a transformer or a link for test purposes.

**5B.8.1.7** All materials, fittings, etc, used in earthing shall conform to Standard specifications, wherever these exist.

**5B.8.1.8** Earthing associated with current-carrying conductor is normally essential for the security of the system and is generally known as system earthing, while earthing of non-current carrying metal work and conductor is essential for the safety of human life, of animals and of property and it is generally known as equipment earthing.

## **5B.8.2 Earth Electrodes**

Earth electrode either in the form of pipe electrode or plate electrode should be provided at all premises for providing an earth system. Details of typical pipe and plate earth electrodes are given in Fig.3 and Fig.4.

Although electrode material does not affect initial earth resistance, care should be taken to select a material which is resistant to corrosion in the type of soil in which it is used. Under ordinary conditions of soil, use of copper, iron or mild steel electrodes is recommended. In case where soil condition leads to excessive corrosion of the electrode, and the connections, it is recommended to use either copper electrode or copper clad electrode or zinc coated galvanized iron electrode. The electrode shall be kept free from paint, enamel and grease. It is recommended to use similar material for earth electrodes and earth conductors or otherwise precautions should be taken to avoid corrosion.

**5B.8.3** As far as possible, all earth connections shall be visible for inspection and shall be carefully made; if they are poorly made or inadequate for the purpose for which they are intended, loss of life and property or serious personal injury may result.

To obtain low overall resistance the current density should be as low as possible in the medium adjacent to the electrodes; which should be so designed as to cause the current density to decrease rapidly with distance from the electrode. This requirement is met by making the dimensions in one direction large compared with those in the other two, thus a pipe, rod or strip has a much lower resistance than a plate of equal surface area. The resistance is not, however, inversely proportional to the surface area of the electrode.

#### **5B.8.4 Equipment and Portions of Installations which shall be Earthed**

##### **5B.8.4.1 Equipment to be Earthed**

Except for equipment provided with double insulation, all the non-current carrying metal parts of electrical installations are to be earthed properly. All metal conduits, trunking, cable sheaths, switchgear, distribution fuse boards, lighting fittings and all other parts made of metal shall be bent together and connected by means of two separate and distinct conductors to an efficient earth electrode.

##### **5B.8.4.2 Structural Metal Work**

Earthing of the metallic parts shall not be effected through any structural metal work which houses the installation. Where metallic parts of the installation are not required to be earthed and are liable to become alive should the insulations of conductors become defective, such metallic parts shall be separated by durable non-conducting material from any structural work.

#### **5B.8.5 Neutral Earthing**

To comply with Myanmar Electricity Rules no fuses or circuit breakers other than a linked circuit breaker shall inserted in an earthed neutral conductor, a linked switch or linked circuit breaker shall be arranged to break or the neutral either with or after breaking all the related phase conductors and. shall positively make (or close) the neutral before making (or closing) the phases.

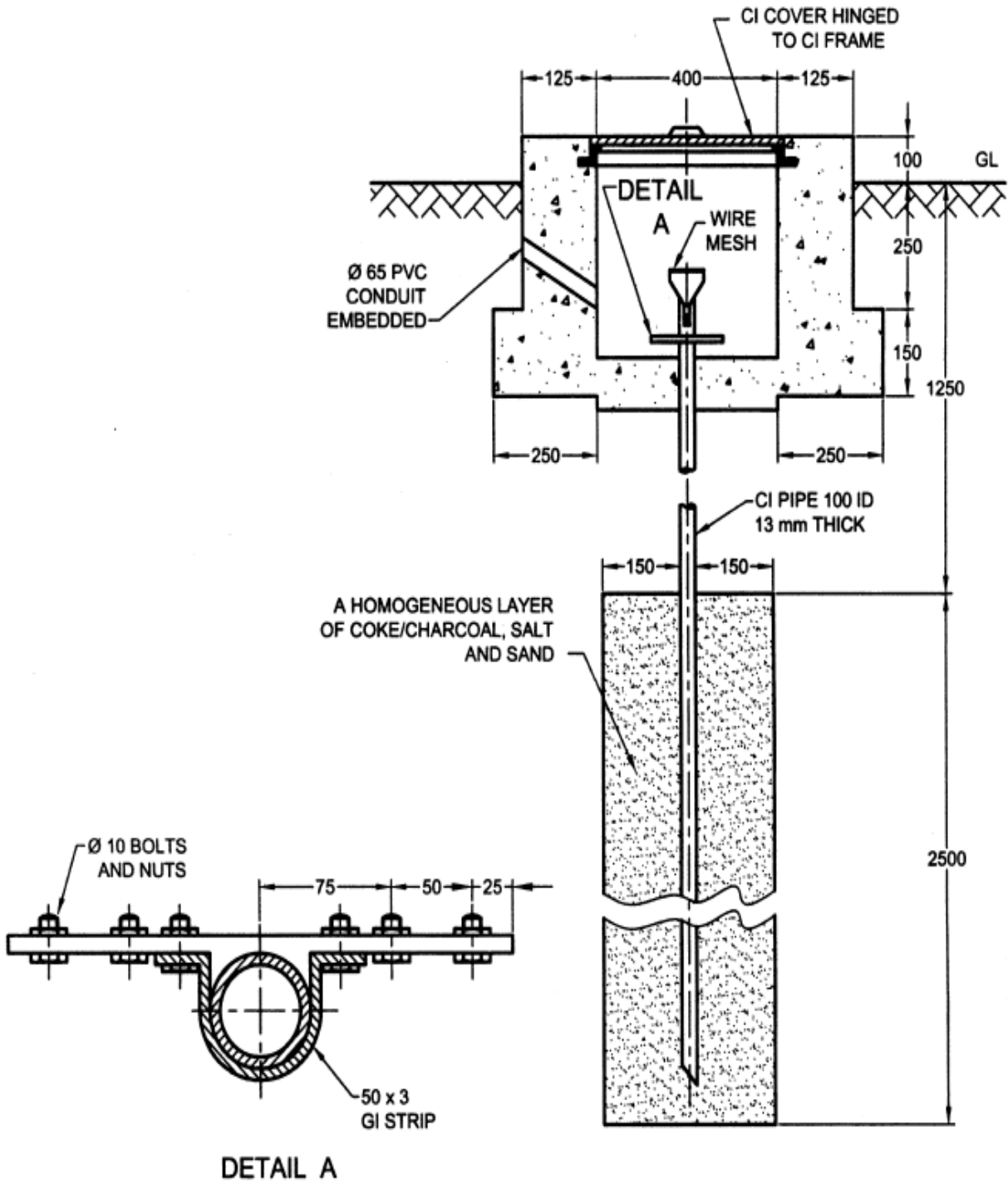

All dimensions in millimeters

Fig. 3 Typical Arrangement of Pipe Earthing

If this neutral point of the supply system is connected permanently to earth, then the above rule applies throughout the installation including 2-wire final circuits. This means that no fuses may be inserted in the neutral or common return wire. And the neutral should consist of a bolted solid link, or part of a linked switch, which completely disconnects the whole system from the supply. This linked switch must be arranged so that the neutral makes before, and break after the phases.

#### **5B.8.6 System of Earthing**

Equipment and portions of installations shall be deemed to be earthed only if earthed in accordance with either the direct earthing system, the multiple earthed neutral system or the earth leakage circuit breaker system. In all cases, the relevant provisions of Myanmar Electricity Rules shall be complied with.

The earthing of electrical installations for nonindustrial and industrial buildings shall be done in accordance with Standard practice [(24) IS 3043].

#### **5B.8.7 Classification of Earthing System**

The earthing systems are classified as follows:

- a) *TN System*— A system which has one or more points of the source of energy directly earth, and the exposed and extraneous conductive parts of the installation are connected by means of protective conductors to the earth points of the source, that is, currents to flow from the installation to the earth points of the source.
- b) *TT System*— A system which has one or more points of the source of energy directly earth, and the exposed and extraneous conductive parts of the installation are connected to a local earth electrodes or electrodes electrically independent of the source earth.
- c) *IT System*— A system which has source either unearthed or earthed through a high impedance and the exposed conductive parts of the installations are connected to electrically independent earth electrodes.

### **5B.9 INSPECTION AND TESTING OF INSTALLATION**

#### **5B.9.1 General Requirements**

**5B.9.1.1** Before the completed installation, or an addition to the existing installation, is put into service, inspection and testing shall be carried out in accordance with the Myanmar Electricity Rules. In the event of defects being found, these shall be rectified, as soon as practicable and the installation retested.

**5B.9.1.2** Periodic inspection and testing shall be carried out in order to maintain the installation in a sound condition after putting into service.

**5B.9.1.3** Where an addition is to be made to the fixed wiring of an existing installation, the latter shall be examined for compliance with the recommendations of the Code.

**5B.9.1.4** The individual equipment and materials which form part of the installation shall generally conform to the relevant Standard Specification wherever applicable.

#### **5B.9.1.5 Completion Drawings**

On completion of the electric work, a wiring diagram shall be prepared and submitted to the engineer-in-charge or the owner. All wiring diagrams shall indicate clearly, the main switch board, the runs of various mains and submains and the position of all points and their controls. All circuits shall be clearly indicated and numbered in the wiring diagram and all

points shall be given the same number as the circuit in which they are electrically connected. Also the location and number of earth points and the run of each load should be clearly shown in the completion drawings.

## **5B.9.2 Inspection of the Installation**

### **5B.9.2.1 General**

On completion of wiring a general inspection shall be carried out by competent personnel in order to verify that the provisions of this Code and that of Myanmar Electricity Rules, have been complied with. This, among other things, shall include checking whether all equipments, fittings, accessories, wires/cables, used in the installation are of adequate rating and quality to meet the requirement of the load. General workmanship of the electrical wiring with regard to the layout and finish shall be examined for neatness that would facilitate easy identification of circuits of the system, adequacy of clearances, soundness, contact pressure and contact area. A complete check shall also be made of all the protective devices, with respect to their ratings, range of settings and co-ordination between the various protective devices.

### **5B.9.2.2 Item to be Inspected**

#### **5B.9.2.2.1 Substation installations**

In substation installation, it shall be checked whether:

- 1) The installation has been carried out in accordance with the approved drawings;
- 2) Phase-to-phase and phase to earth clearances are provided as required;
- 3) All equipments are efficiently earthed and properly connected to the required number of earth electrodes;
- 4) The required ground clearance to live terminals is provided;
- 5) Suitable fencing is provided with gate with lockable arrangements;
- 6) The required number of caution boards fire-fighting equipments, operating rods, rubber mats, etc, are kept in the substation;
- 7) In case of indoor substation sufficient ventilation and draining arrangements are made;
- 8) All cable trenches are provided with non-inflammable covers;
- 9) Free accessibility is provided for all equipments for normal operation;
- 10) All name plates are fixed and the equipments are fully painted;
- 11) All construction materials and temporary connections are removed;
- 12) Oil-level, busbar tightness, transformer tap position, etc, are in order;
- 13) Earth pipe troughs and cover slabs are provided for earth electrodes/earth pits and the neutral and LA earth pits are marked for easy identification;
- 14) Earth electrodes are of GI pipes or CI pipes or copper plates. For earth connections, brass bolts and nuts with lead washers are provided in the pipes/plates;
- 15) Earth pipe troughs and oil sumps/pits are free from rubbish and dirt and stone jelly and the earth connections are visible and easily accessible;



- 16) HT and LT panels switchgears are all vermin and damp-proof and all unused openings or holes are blocked properly;
- 17) The earth bus bars have tight connections and corrosion-free joint surfaces;
- 18) Operating handle of protective devices are provided at an accessible height from ground;
- 19) Adequate headroom is available in the transformer room for easy topping-up of oil, maintenance, etc;
- 20) Safety devices, horizontal and vertical barriers, bus bar covers/shrouds, automatic safety shutters/doors interlock, handle interlock are safe and in reliable operation in all panels and cubicles;
- 21) Clearances in the front, rear and sides of the main HV and MV and sub-switch boards are adequate;
- 22) The switches operate freely; the 3 blades make contact at the same time, the arcing horns contact in advance; and the handles are provided with locking arrangements;
- 23) Insulators are free from cracks, and are clean;
- 24) In transformers, there is any oil leak;
- 25) Connections to bushing in transformers for tightness and good contact;
- 26) Bushings are free from cracks and are clean;
- 27) Accessories of transformers like breathers, vent pipe, Buchholz relay, etc, are in order;
- 28) Connections to gas relay in transformers are in order;
- 29) Oil and winding temperature are set for specific requirements in transformers;
- 30) In case of cable cellars, adequate arrangements to pump out water that has entered due to see page or other reasons;
- 31) All incoming and outgoing circuits of HV and MV panels are clearly and indelibly labeled for identifications;
- 32) No cable is damaged;
- 33) There is adequate clearance around the equipments installed; and
- 34) Cable terminations are proper.

#### **5B.9.2.2.2 Medium voltage installation**

In medium voltage installations, it shall be checked whether:

- 1) All blocking materials that are used for safe transportation in switchgears, contactors, relays, etc, are removed;
- 2) All connections to be earthing system are feasible for periodical inspection;
- 3) Sharp cable bends are avoided and cables are taken in a smooth manner in the trenches or alongside the walls and ceilings using suitable support clamps at regular intervals;

## ELECTRICAL AND ALLIED INSTALLATIONS

- 4) Suitable linked switch or circuit breaker or lockable push button is provided near the motors/apparatus for controlling supply to the motor/apparatus in an easily accessible location;
- 5) Two separate and distinct earth connections are provided for the motor/apparatus;
- 6) Control switch-fuse is provided at an accessible height from ground for controlling supply to overhead travelling crane, hoists, overhead bus bar trunking;
- 7) The metal rails on which the crane travels are electrically continuous and earthed and bonding of rails and earthing at both ends are done;
- 8) Four core cables are used for overhead travelling crane and portable equipments, the fourth core being used for earthing, and separate supply for lighting circuit is taken;
- 9) If flexible metallic hose is used for wiring to motors and other equipment, the wiring is enclosed to the full lengths, and the hose secured properly by approved means;
- 10) The cables are not taken through areas where they are likely to be damaged or chemically affected;
- 11) The screens and armours of the cables are earthed properly;
- 12) The belts of the belt driven equipments are properly guarded;
- 13) Adequate precautions are taken to ensure that no live parts are so exposed as to cause danger;
- 14) Ammeters and voltmeters are tested;
- 15) The relays are inspected visually by moving covers for deposits of dusts or other foreign matter;
- 16) Wherever bus ducts/rising mains/overhead bus trucking are used, special care should be taken for earthing the system. All tap off points shall be provided with adequately rated protective device like MCB, MCCB, fuses, ELCB, RCCB, etc;
- 17) All equipments shall be weather, dust and vermin proof; and
- 18) Any and all equipments having air insulation as media shall maintain proper distances between phases; phase to neutral; phase to earth and earth to neutral.

### **5B.9.2.2.3 Overhead lines**

For overhead lines it shall be checked whether:

- 1) All conductors and apparatus including live parts thereof are inaccessible;
- 2) The types and size of supports are suitable for the overhead lines/conductors used and are in accordance with approved drawing and standards;
- 3) Clearances from ground level to the lowest conductor of overhead lines, sag conditions, etc, are in accordance with the relevant standard;
- 4) Where overhead lines cross the roads or cross each other or are in proximity with one another, suitable guarding is provided at road crossings and also to protect against possibility of the lines coming in contact with one another;
- 5) Every guard wire is properly earthed;

- 6) The type, size and suitability of the guarding arrangement provided is adequate;
- 7) Stays are provided suitably on the over-head lines as required and are efficiently earthed or provided with suitably stay insulators of suitable voltages;
- 8) Anti-climbing devices and Danger Board/Caution Board Notices are provided on all HT supports;
- 9) Clearances along the route are checked and all obstructions such as trees/branches and shrubs are cleared on the route to the required distance on either side;
- 10) Clearance between the live conductor and the earthed metal parts are adequate;
- 11) For the service connections tapped-off from the overhead lines, cut-outs of adequate capacity are provided;
- 12) All insulators are properly and securely mounted; also they are not damaged.
- 13) All poles are properly grouted/insulated so as to avoid bending of pole towards tension; and
- 14) Steel poles, if used shall be properly earthed.

#### **5B.9.2.2.4 Lighting circuits**

The lighting circuits shall be checked whether:

- 1) Wooden boxes and panels are avoided in factories for mounting the lighting boards and switch controls, etc;
- 2) Neutral links are provided in double poles with fuses which are used for lighting control, and no protective devices (such as MCB, MCCB, fuses, ELCB, etc) is provided in the neutral;
- 3) The plug points in the lighting circuit are all of 3-pin type, the third pin being suitably earthed;
- 4) Tamper-proof interlocked switch socket and plug are used for locations easily accessible;
- 5) Lighting wiring in factory area is taken enclosed in conduit and conduit properly earthed, or alternatively, armoured cable wiring is used;
- 6) A separate earth wire is run in the lighting installation to provide earthing for plug points, fixtures and equipments;
- 7) Proper connectors and junction boxes are used wherever joints are to be made in conductors or cross over of conductors takes place;
- 8) Cartridge fuse units are fitted with cartridge fuses only;
- 9) Clear and permanent identification marks are painted in all distribution boards, switchboards, sub-main boards and switches as necessary;
- 10) The polarity having been checked and all protective devices (such as MCB, MCCB, fuses, ELCB, etc) and single pole switches are connected on the phase conductor only and wiring is correctly connected to socket outlets;

## ELECTRICAL AND ALLIED INSTALLATIONS

- 11) Spare knockouts provided in distribution boards and switch fuses are blocked;
- 12) The ends of conduits enclosing the wiring leads are provided with ebonite or other suitable bushes;
- 13) The fittings and fixtures used for outdoor use are all of weather-proof construction, and similarly, fixtures, fittings and switchgears used in the hazardous area, are of flame-proof application;
- 14) Proper terminal connectors are used for termination of wires (conductors and earth leads) and all strands are inserted in the terminals;
- 15) Flat ended screws are used for fixing conductor to the accessories;
- 16) Use of flat washers backed up by spring washers for making end connections is desirable; and
- 17) All metallic parts of installation such as conduits, distribution boards, metal boxes, etc have been properly earthed.

### 5B.9.3 Testing of Installation

#### 5B.9.3.1 General

After inspection, the following tests shall be carried out, before an installation or an addition to the existing installation is put into service. Any testing of the electrical installation in an already existing installation shall commence after obtaining permit to work from the engineer-in-charge and after ensuring the safety provisions.

#### 5B.9.3.2 Testing

##### 5B.9.3.2.1 Switchboards

HV and MV switchboards shall be tested in the manner indicated below:

- a) All high voltage switchboards shall be tested for dielectric test as per Standard practice [(25) IS 8623]
- b) All earth connections shall be checked for continuity.
- c) The operation of the protective devices shall be tested by means of secondary or primary injection tests.
- d) The operation of the breakers shall be tested from all control stations.
- e) Indication/signaling lamps shall be checked for proper working.
- f) The operation of the breakers shall be tested for all interlocks.
- g) The closing and opening timings of the breakers shall be tested wherever required for auto-transfer schemes.
- h) Contact resistance of main and isolator contacts shall be measured.
- i) The specific gravity and the voltage of the control battery shall be measured.

##### 5B.9.3.2.2 Transformers

Transformers are tested in the manner indicated below:

- a) All commissioning tests shall be in accordance with Standard practice [(26) IS 10028].

- b) Insulation resistance on HV and MV windings shall be measured at the end of 1 min as also at the end of 10 min of measuring the polarization index. The absolute value of insulation resistance should not be the sole criterion for determining the state of dryness of the insulation. Polarization index values should form the basis for determining the state of dryness of insulation. For any class of insulation, the polarization index should be greater than 1.5.

#### 5B.9.3.2.3 Cables

Cable installations shall be checked as below:

- a) It shall be ensured that the cables conform to the relevant Standards. Tests shall also be done in accordance with Standard practice [(6) IS 732]. The insulation resistance before and after the tests shall be checked.
- b) The insulation resistance between each conductor and against earth shall be measured. The insulation resistance varies with the type of insulation used and with the length of cable. The following empirical rule gives reasonable guidance:

$$\begin{aligned} &\text{Insulation resistance in megaohms} \\ &= \frac{10 \times \text{Voltage in kV}}{\text{Length in km}} \end{aligned}$$

- c) Physical examination of cables shall be carried out.
- d) Cable terminations shall be checked.
- e) Continuity test shall be performed before charging the cable with current.

#### 5B.9.3.2.4 Motors and other equipments

The following test is made on motor and other equipment:

The insulation resistance of each phase winding against the frame and between the windings shall be measured. Megger of 500 V or 1 000 V rating shall be used. Star points should be disconnected. Minimum acceptable value of the insulation resistance varies with the rated power and the rated voltage of the motor.

The following relation may serve as a reasonable guide:

$$R_i = \frac{20 \times E_n}{1000 + 2P}$$

where

$R_i$  = Insulation resistance in megaohms at 25 °C.

$E_n$  = Rated phase to phase voltage.

$P$  = Rated power in kW.

If the resistance is measured at a temperature different from 25°C, the value shall be corrected to 25°C.

The insulation resistance as measured at ambient temperature does not always give a reliable value, since moisture might have been absorbed during shipment and storage. When the temperature of such a motor is raised, the insulation resistance will initially

drop considerably, even below the acceptable minimum. If any suspicion exists on this score, motor winding must be dried out.

#### **5B.9.3.2.5 Wiring installation**

The following tests shall be done:

- a) The insulation resistance shall be measured by applying between earth and the whole system of conductor or any section thereof with all fuses in place and all switches closed, and except in earthed concentric wiring, all lamps in position or both poles of installation otherwise electrically connected together, a dc voltage of not less than twice the working voltage, provided that it does not exceed 500 V for medium voltage circuits. Where the supply is derived from three –wire (ac or dc) or a poly-phase system, the neutral pole of which is connected to earth either direct or through added resistance the working voltage shall be deemed to be that which is maintained between the outer or phase conductor and the neutral.
- b) The insulation resistance in megaohms of an installation measured as in (a) shall be not less than 50 divided by the number of points on the circuit, provided that the whole installation need not be required to have an insulation resistance greater than one megaohm.
- c) Control rheostats, heating and power appliances and electric signs, may, if desired, be disconnected from the circuit during the test, but in that event the insulation resistance between the case of framework, and all live parts of each rheostat, appliance and sign shall be not less than that specified in the relevant Standard specification or where there is no such specification, shall be not less than half a megaohm.
- d) The insulation resistance shall also be measured between all conductors connected to one pole or phase conductor of the supply and all the conductors connected to the middle wire or to the neutral on to the other pole of phase conductors of the supply. Such a test shall be made after removing all metallic connections between the two poles of the installation and in these circumstances the insulation resistance between conductors of the installation shall be not less than that specified in (b).

#### **5B.9.3.2.6 Completion certificate**

On completion of an electrical installation (or an extension to an installation) a certificate shall be furnished by the contractor, counter-signed by the certified supervisor under whose direct supervision the installation was carried out. This certificate shall be in a prescribed form as required by the local electric supply authority. One such recommended form is given in **Annex D**.

#### **5B.9.3.2.7 Earthing**

For checking the efficiency of earthing, the following tests are done:

- a) The earth resistance of each electrode shall be measured.
- b) Earth resistance of earthing grid shall be measured.
- c) All electrodes shall be connected to the grid and the earth resistance of the entire earthing system shall be measured.

These tests shall preferably be done during the summer months.

### **5B.10 TELECOMMUNICATION AND OTHER MISCELLANEOUS SERVICES**

**15B.0.1 Telecommunication Service**

**5B.10.1.1** House wiring of telephone subscribers offices in small buildings is normally undertaken by the Telephone Department on the surface of walls. And the user (subscriber) likes to have extension or place to another location inside the same apartment/house; the work should be undertaken with the instruction from the Auto Telephone Department. But in large multi- storied buildings intended for commercial, business and office use as well as for residential purposes, wiring for telephone connections is generally done in a concealed manner through conduits. The telephone wiring diagrams of the multi-storied building should be consulted and appalled for the permission to use to the Auto Telephone Department in prior to the completion of building construction.

**5B.10.1.2** The requirements of telecommunication facilities like Telephone connections, Private Branch Exchange, Intercommunication facilities, Telex and Telegraph lines are to be planned well in advance so that suitable provisions are made in the building plan in such a way that the demand for telecommunication services in any part of the building at any floor are met at any time during the life of the building.

**5B.10.1.3** Layout arrangements, methods for internal block wiring and other requirements regarding provisions of space, etc, may be decided depending as the number of phone outlets and other details in consultation with Engineer/Architect and user. Those arrangement/methods & requirements should be consulted with respective Auto Telephone Department / Information Technology Department for the safety and effectiveness of the materials usage.

**5B.10.2 Public Address System — See Fire Department Instructions.****5B.10.3 Common Antenna System for TV Receivers**

**5B.10.3.1** In multi-storied apartments, houses and hotels where many TV receivers are located, a common master antenna system may preferably be used to avoid mushrooming of individual antennas.

**5B.10.3.2** Master antenna is generally provided at the top most convenient point in any building and a suitable room on the top most floors or terrace for housing the amplifier unit, etc, may also be provided in consultation with the architect/engineer.

**5B.10.3.3** From the amplifier rooms, conduits are laid in recess to facilitate drawing co-axial cable to individual flats. Suitable ‘Tap Off’ boxes may be provided in every room/flat as required.

**5B.10.4 UPS System**

An electrical device providing an interface between the mains power supply and sensitive loads (computer systems, instrumentation, etc). The UPS supplies sinusoidal ac power free of disturbances and within strict amplitude and frequency tolerances. It is generally made up of a rectifier/charger and an inverter together with a battery for backup power in the event of a mains failure with virtually no time lag.

In general UPS system shall be provided for sensitive electronic equipments like computers, printers, fire alarm panel, public address system equipment, access control panel, EPABX, etc with the following provisions:

- a) Provisions of isolation transformers shall be provided where the capacity exceeds 5 kVA.

## ELECTRICAL AND ALLIED INSTALLATIONS

- b) UPS shall have dedicated neutral earthing system.
- c) Adequate rating of protective devices such as MCB, MCCB, fuses, ELCB, etc, shall be provided at both incoming and outgoing sides.
- d) UPS room shall be provided with adequate ventilation and/or air conditioning as per requirement.

### 5B.10.5 Inverter

In general inverter system shall be provided for house lighting, shop lighting, etc, with the following provisions:

- a) Adequate rating of protective devices such as MCB, MCCB, fuses, ELCB, etc, shall be provided at both incoming and outgoing sides.
- b) Earthing shall be done properly.
- c) Adequate ventilation space shall be provided around the battery section of the inverter.
- d) Care in circuit design to keep the connected load in such a manner that the demand at the time of mains failure is within the capability of the inverter. (If the inverter fails to take over the load at the time of the mains failure, the purpose of providing the inverter and battery backup is defeated.)
- e) Circuits which are fed by the UPS or Inverter systems should have suitable marking to ensure that a workman does not assume that the power is off, once he has switched off the mains from the DB for maintenance.
- f) UPS systems and Inverter systems have a very limited fault feeding capacity in comparison to the mains supply from the licensee's network. The low fault current feed may cause loss of discrimination in the operation of MCB's, if the Inverter or UPS system feeds a number of circuits with more than one over current protective device in series (such as incoming MCB at the DB and a few outgoing MCB'S). The choice of MCB's in such cases has to be done keeping the circuit operating and fault condition parameters under both (mains operation and UPS operation) conditions.

### 5B.10.6 Diesel Generating Set (less than 5 kVA)

In general small diesel generating sets shall be provided for small installations such as offices, shops, small scale industry, hostels, etc, with the following provisions:

- a) These shall be located near the exit or outside in open areas.
- b) They shall be in reach of authorized persons only.
- c) Adequate fire-fighting equipment shall be provided near such installations.
- d) Exhaust from these shall be disposed in such a way so as not to cause health hazard.
- e) These shall have acoustic enclosure, or shall be placed at a location so as not to cause noise pollution.
- f) Adequate ventilation shall be provided around the installation.
- g) Adequate rating of protective devices such as MCB, MCCB, fuses, ELCB, etc shall be provided.
- h) Separate and adequate body and neutral earthlings shall be done.

### 5B.10.7 Building Management System



A building management/automation system may be considered to be provided for controlling and monitoring of all parameters of HVAC, electrical, plumbing, fire fighting, low voltage system such as telephone, TV, etc. This not only lead to reduction of energy consumption, it shall also generate data leading to better operation practice and systematic maintenance scheduling. The total overview provided by a Building Automation System, with a capability to oversee a large number of operating and environmental parameters on real time basis leads to introduction of measures which lead to further reduction in energy consumption.

It shall also help in reduction of skilled manpower required for operation and maintenance of large complexes. This system can further linked to other systems such as Fire alarm system, public address system, etc for more effective running of services.

This system can be used for analysis and controlling of all services in a particular complex, leading efficient and optimum utilization of available services.

#### **5B.10.8 Security System**

Security System may be defined as an integrated Closed Circuit Television System, Access Control System, Perimeter Protection Systems, movement sensors, etc. These have a central control panel, which has a defined history storage capacity. This main control panel may be located near to the fire detection and alarm system.

These may be considered for high security areas or large crowded areas or complexes. High security areas may consider uncoded, high-resolution, black and white cameras in place of colored cameras. These may be accompanied with movement sensors.

Access control may be provided for entry to high security areas. The systems may have proximity card readers, magnetic readers, etc.

#### **5B.10.9 Computer Networking**

Networking is the practice of linking computing devices together with hardware and software that supports data communications across these devices.

#### **5B.10.10 Car Park Management System**

The Car Management System may be provided in multi-level parking or other parking lots where number of vehicles to be parked exceeds 1000 vehicles. The Car Park Management System may have features of Pay and Display Machines and Parking Guidance System. The Pay and Display Machines may be manned and unmanned type. Parking guidance system needs to display number of car spaces vacant on various floors, direction of entry and exit, etc. This system can be of great benefit in evaluating statistical data's such as number of cars in a day or month or hour, stay time of various vehicles, etc.

### **5B.11 LIGHTNING PROTECTION OF BUILDINGS**

#### **5B.11.1 Basic Considerations for Protection**

Before proceeding with the detailed design of a lightning protecting system, the following essential steps should be taken:

- a) Decide whether or not the structure needs protection and, if so, what are the special requirements (*see 5B.11.1.1*) {*see* Standard practice for details [(27) IS 2309]}
- b) Ensure a close liaison between the architect, the builder, the lightning protective system engineer, and the appropriate authorities throughout the design stages.

c) Agree the procedures for testing, commissioning and future maintenance.

#### **5B.11.1.1 Need for Protection**

Structures with inherent explosive risks; for example, explosives factories, stores and dumps and fuel tanks; usually need the highest possible class of lightning protective system.

For all other structures, the standard of protection recommended in the remainder of the Code is applicable and the only question remaining is whether to protect or not.

In many cases, the need for protection may be self-evident, for example:

- where large numbers of people congregate;
- where essential public services are concerned;
- where the area is one in which lightning strokes are prevalent;
- where there are very tall or isolated structures; and
- where there are structures of historic or cultural importance.

However, there are many cases for which a decision is not so easy to make. Various factors effecting the risk of being struck and the consequential effects of a stroke in these cases are discussed in **5B.11.1.2** to **5B.11.1.8**.

It must be understood, however, that some factors cannot be assessed, and these may override all other considerations. For example, a desire that there should be no avoidable risk to life or that the occupants of a building should always feel safe, may decide the question in favour of protection, even though it would normally be accepted that there was no need. No guidance can be given in such matters, but an assessment can be made taking account of the exposure risk (that is the risk of the structure being struck) and the following factors:

- a) Use to which the structure is put,
- b) Nature of its construction,
- c) Value of its contents or consequential effects,
- d) The location of the structure, and
- e) The height of the structure (in the case of composite structures the overall height).

#### **5B.11.1.2 Estimation of Exposure Risk**

The probability of a structure or building being struck by lightning in any one year is the product of the 'lightning flash density' and the 'effective collection area' of the structure. The lightning flash density,  $N_g$ , is the number of (flashes to ground) per  $\text{km}^2$  per year.

NOTE — For the purposes of this Code, the information given in Figure 5 on thunderstorm days per year would be necessary to be translated in terms of estimated average annual density  $N_g$

The table below which indicates the relationship between thunderstorm days per year and lightning flashes per square kilometer per year:

<i>Thunderstorm days/year</i>	<i>Lightning Flashes per km<sup>2</sup> per Year</i>	
	Mean	Limits
5	0.2	0.1-0.5
10	0.5	0.15-1
20	1.1	0.3-3
30	1.9	0.6-5
40	2.8	0.8-8
50	3.7	1.2-10
60	4.7	1.8-12
80	6.9	3-17
100	9.2	4 – 20

The effective collection area of a structure is the area on the plan of the structure extended in all directions to take account of its height. The edge of the effective collection area is displaced from the edge of the structure by an amount equal to the height of the structure at that point. Hence, for a simple rectangular building of length L, width W and height H meters, the collection area has length (L + 2H) meters and width (W+ 2 H) meters with four rounded corners formed by quarter circles of radius H meters. This gives a collection area, A<sub>c</sub> (in m<sup>2</sup>):

$$A_c = (L \times W) + 2 (L \times H) + 2 (W \times H) + \pi H^2 \quad \dots (1)$$

The probable number of strikes (risk) to the structure per year is:

$$P = A_c \times N_g \times 10^{-6} \quad \dots (2)$$

It must first be decided whether this risk P is acceptable or whether some measure of protection is thought necessary.

#### **5B.11.1.3 Suggested Acceptable Risk**

For the purposes of this Code, the acceptable risk figure has been taken as 10<sup>-5</sup>, that is, 1 in 100 000 per year.

#### **5B.11.1.4 Overall Assessment of Risk**

Having established the value of P, the probable number of strikes to the structure per year [see equation (2) in **5B.11.1.2**] the next step is to apply the 'weighting factors' in **Tables 3** and **4**.

This is done by multiplying P by the appropriate factors to see whether the result, the overall weighting factors, exceeds the acceptable risk of P = 10<sup>-5</sup> per year.

**5B.11.1.5 Weighting Factors**

In Tables 3A to 3E, the weighting factor values are given under headings 'A' to 'E', denoting a relative degree of importance or risk in each case. The tables are mostly self-explanatory but it may be helpful to say something about the intention of **Table 3C**.

Table 3: Overall Assessment of Risk  
(Clauses 11.1.4 and 11.1.5)

Table 3A: Weighting Factor 'A'  
(Use of Structure)

Use to Which Structure is Put	Value of 'A'
Houses and other buildings of comparable size	0.3
Houses and other buildings of comparable size with outside aerial	0.7
Factories, workshops and laboratories	1.0
Office blocks, hotels, blocks of flats and other residential buildings other than those included below	1.2
Places of assembly, for example, churches, halls, theatres, museums, exhibitions, departmental stores, post offices, stations, airports, and stadium structures	1.3
Schools, hospitals, children's and other homes	1.7

Table 3B: Weighting Factor 'B'  
(Type of Construction)

Type of Construction	Value of 'B'
Steel framed encased with any roof other than metal <sup>1)</sup>	0.2
Reinforced concrete with any roof other than metal	0.4
Steel framed encased or reinforced concrete with metal roof	0.8
Brick, plain concrete or masonry with any roof other than metal or thatch	1.0
Timber framed or clad with any roof other than metal or thatch	1.4
Brick, plain concrete, masonry, timber framed but with metal roofing	1.7

**ELECTRICAL AND ALLIED INSTALLATIONS**

Any building with a thatched roof	2.0
-----------------------------------	-----

<sup>1)</sup> A structure of exposed metal which is continuous down to ground level is excluded from these tables as it requires no lightning protection beyond adequate earthing arrangements.

Table 3C: Weighting Factor 'C'  
(Contents or Consequential Effects)

<b>Contents or Consequential Effects</b>	<b>Value of 'C'</b>
Ordinary domestic or office buildings, factories and workshops not containing valuable or specially susceptible contents	0.3
Industrial and agricultural buildings with specially susceptible <sup>1)</sup> contents	0.8
Power stations, gas works, telephone exchanges, radio stations	1.0
Industrial key plants, ancient monuments and historic buildings, museums, art galleries or other buildings with specially valuable contents	1.3
Schools, hospitals, children's and other homes, places of assembly	1.7
<sup>1)</sup> This means specially valuable plant or materials vulnerable to fire or the results of fire	

Table 3D: Weighting Factor 'D'  
(Degree of Isolation)

<b>Degree of Isolation</b>	<b>Value of 'D'</b>
Structure located in a large area of structures or trees of the same or greater height, for example, in a large town or forest	0.4
Structure located in an area with few other structures or trees of similar height	1.0
Structure completely isolated or exceeding at least twice the height of surrounding structures or trees	2.0

Table 3E: Weighting Factor 'E'  
(Type of Country)

<b>Type of Country</b>	<b>Value of 'E'</b>
------------------------	---------------------

Flat country at any level	0.3
Hill country	1.0
Mountain country between 300 m and 900 m	1.3
Mountain country above 900 m	1.7

The effect of the value of the contents of a structure is clears the term 'consequential effect' is intended to cover not only material risks to goods and property but also such aspects as the disruption of essential services of all kinds, particularly in hospitals.

The risk to life is generally very small, but if a building is struck, fire or panic can naturally result. All possible steps should, therefore, be taken to reduce these effects, especially among children, the old, and the sick.

#### **5B.11.1.6 Interpretation of Overall Risk Factor**

The risk factor method put forward here is to be taken as giving guidance on what might, in some cases, be a difficult problem. If the result obtained is considerably less than  $10^{-5}$  (1 in 100 000) then, in the absence of other overriding considerations, protection does not appear necessary; if the result is greater than  $10^{-5}$ , say for example  $10^{-4}$  (1 in 10 000) then sound reasons would be needed to support a decision not to give protection.

When it is thought that the consequential effects will be small and that the effect of a lightning stroke will most probably be merely slight damage to the fabric of the structure, it may be economic not to incur the cost of protection but to accept the risk. Even though, this decision is made, it is suggested that the calculation is still worthwhile as giving some idea of the magnitude of the calculated risk being taken.

#### **5B.11.1.7 Anomalies**

Structures are so varied that any method of assessment may lead to anomalies and those who have to decide on protection must exercise judgement. For example, a steel-framed building may be found to have a low risk factor but, as the addition of an air termination and earthing system will give greatly improved protection, the cost of providing this may be considered worthwhile.

A low risk factor may result for chimneys made of brick or concrete. However, where chimneys are free standing or where they project for more than 4.5 m above the adjoining structure, they will require protection regardless of the factor. Such chimneys are, therefore, not covered by the method of assessment. Similarly, structures containing explosives or flammable substances are also not covered.

Results of calculations for different structures are given in **Table 4** and a specific case is worked through in **5B.11.1.8**.

#### **5B.11.1.8 Sample Calculation of Need for Protection**

A hospital building is 10 m high and covers an area of 70 m x 12 m. The hospital is located in flat country and isolated from other structures. The construction is of brick and concrete with a non-metallic roof. Is lightning protection needed ?

a) *Flashes/km<sup>2</sup>/year* — Let us say, for the protection of the hospital a value for Ng is

SI No.	Description of Structure	Risk of Being Struck(p)	Weighting Factors	Overall Multi-	Overall Risk Factor	Recommendation.
--------	--------------------------	-------------------------	-------------------	----------------	---------------------	-----------------

0.7.

b) *Collection area*— Using equation (1) in **5B.11.1.2:**

$$A_c = (70 \times 12) + 2(70 \times 10) + 2(12 \times 10) + (\pi \times 100)$$

$$= 840 + 1400 + 240 + 314 = 2794 \text{ m}^2$$

c) *Probability of being struck*— Using equation (2) in **5B.11.1.2:**

$$P = A_c \times N_g \times 10^{-6} \text{ times per year}$$

$$= 2794 \times 0.7 \times 10^{-6} = 2.0 \times 10^{-3} \text{ approximately}$$

Table 4: Examples of Calculations for Evaluating the Need for Protection  
(Clauses 5B.11.1.4 and 5B11.1.7)

## ELECTRICAL AND ALLIED INSTALLATIONS

(1)	(2)	(3)	(4)	(5)	(6)	(7)	(8)	(9)	(10)	(11)	(12)	(13)	
		Collection Area $A_c$	Flash Density $N_g$	P $A_c \times N_g \times 10^{-6}$	'A' Use of Structure (Table 3A)	'B' Type of Const (Table 3B)	'C' Contents or Consequen Tial Effects (Table 3C)	'D' Degree of Isolation (Table 3D)	'E' Type of Country (Table 3E)				
i)	Malsonette, reinforced concrete and brick built non-metallic roof	3 327	0.6	$2 \times 10^{-3}$	1.2	0.4	0.3	0.4	0.3	0.02	$4 \times 10^{-5}$	Protection required	
ii)	Office building reinforced concrete construction, non-metallic roof	4 296	0.6	$2.6 \times 10^{-3}$	1.2	0.4	0.3	0.4	0.3	0.02	$5.2 \times 10^{-5}$	Protection required	
iii)	School, brick built	1 456	0.7	$1 \times 10^{-3}$	1.7	1.0	1.7	0.4	0.3	0.3	$3 \times 10^{-4}$	Protection Required	
iv)	3 bedroom detached dwelling house brick built	405	0.4	$1.6 \times 10^{-4}$	0.3	1.0	0.3	0.4	0.3	0.01	$1.6 \times 10^{-4}$	No Protection Required	
v)	Village church	5 027	0.6	$3 \times 10^{-3}$	1.3	1.0	1.7	2.0	0.3	1.3	$3.9 \times 10^{-3}$	Protection Required	

NOTE — The risk of being struck, (col 5), is multiplied by the product of the weighting factors (col 6 to 10) to yield an overall risk factor (col 12). This should be compared with the acceptable risk ( $1 \times 10^{-5}$ ) for guidance on whether or not to protect.

*d) Applying the weighting factors*

$$A = 1.7$$

$$B = 1$$

$$C = 1.7$$



$$D = 2.0$$

$$E = 0.3$$

The overall multiplying factor

$$= A \times B \times C \times D \times E$$

$$= 1.7$$

Therefore, the overall risk factor

$$= 2.0 \times 1.7 \times 10^{-3}$$

$$= 3.4 \times 10^{-3}$$

Conclusion: Protection is necessary.

**5B.11.2** For detailed requirements of lightning protection of various structures, reference may be made to Standard practice [(27) IS 2309].

# MYANMAR

## PLACES FOR AVERAGE NUMBER OF THUNDERSTORMS DAYS IN A YEAR

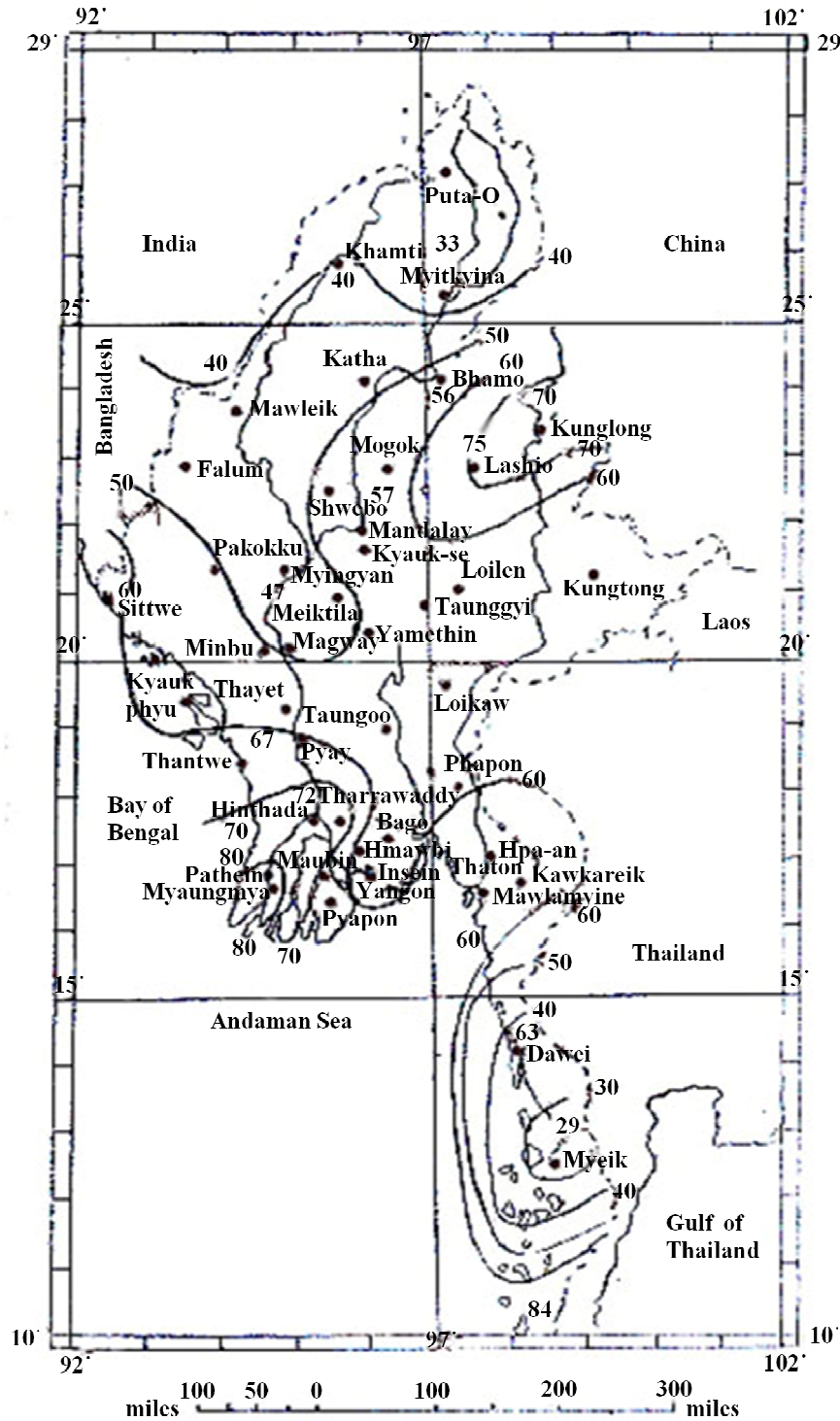











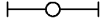

( CONTOUR MAP NEED TO BE UP-DATED )

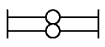
## ANNEX A













[Clause (2.2)]

## DRAWING SYMBOLS FOR ELECTRICAL INSTALLATION IN BUILDING

## A- Lighting Apparatus

SR NO	SYMBOL	DESCRIPTION	SR NO	SYMBOL	DESCRIPTION
1		LAMP	7		CHANDELIER LIGHT
2		FLUORESCENT LAMP, SINGLE, BARE TYPE	8		SPOT LIGHT
3		FLUORESCENT LAMP, DOUBLE, BARE TYPE	9		FLOOD LIGHT
4		DOWN LIGHT	10		BULK HEAD LAMP
5		WALL BRACKET LIGHT	11		EMERGENCY LAMP
6		LIGHTING OUTLET	12		WATER TIGHT LIGHT FITTING

## B- Fans





SR NO	SYMBOL	DESCRIPTION	SR NO	SYMBOL	DESCRIPTION
1		CEILING FAN	7		TELEPHONE OUTLET
2		OSCILLATING FAN, CEILING TYPE	8		TELEVISION OUTLET
3		OSCILLATING FAN, WALL TYPE	9		DATA NETWORK OUTLET
4		EXHAUST FAN, WALL TYPE	10		AMPLIFYING EQUIPMENT
5		EXHAUST FAN, CEILING TYPE	11		SIREN
6		FAN REGULATOR	12		HORN OR HOOTER

**D- Electrical Circuit Diagram**



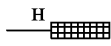



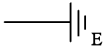



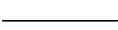

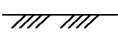
ELECTRICAL AND ALLIED INSTALLATIONS

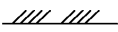
SR NO	SYMBOL	DESCRIPTION	SR NO	SYMBOL	DESCRIPTION
1		TRANSFORMER	18		CONNECTING LINK, open
2		AUTO TRANSFORMER	19		JUNCTION, CONNECTION POINT
3		CURRENT TRANSFORMER	20		TERMINAL
4		FUSE	21		JUNCTION OF CONDUCTOR
5		MINIRATURE CIRCUIT BREAKER	22		TERMINAL BLOCK
6		MOULDED CASE CIRCUIT BREAKER	23		CONDUCTOR
7		SWITCH (Mechanical)	24		THREE CONDUCTOR
8		CIRCUIT BREAKER	25		THREE PHASE CIRCUIT, 50Hz, 380V, Three conductors of 120mm <sup>2</sup> with neutral of 50mm <sup>2</sup>
9		DISCONNECTOR (Isolator)	26		THREE CONDUCTOR IN CABLE
10		2 WAY DISCONNECTOR (Isolator) with off position in the centre	27		CABLE SEALING END, Show with 1no 3core cable
11		SWITCH DISCONNECTOR (Onload isolating switch)	28		CABLE SEALING END, Show with 3nos one core cable
12		CONTACTOR (Contact open in the unoperated position)	29		MOTOR STARTER, General symbol
13		CONTACTOR (Contact close in the unoperated position)	30		STARTER, Operated in steps
14		FUSE SWITCH	31		STARTER, Operated with star-deta
15		FUSE DISCONNECTOR (Fuse Isolator)	32		STARTER, Operated with auto transformer
16		FUSE SWITCH DISCONNECTOR (Onload isolating fuse switch)	33		STARTER, Operated in direct on line with contactor
17		CONNECTING LINK, closed	34		STARTER, Operated with starter regulator with thyristors
35		MACHINE, General symbol *Star mark shall be replaced by a letter designation as follow C Synchronous convertor G Generator GS Synchronous generator M Motor MS Synchronous motor	41		FAULT
			42		FLASH OVER
			43		CLOCK
36		FAN	44		SIGNAL LAMP
37		HEATER	45		SWITCH, General

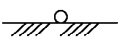

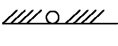







**D- Electrical Circuit Diagram**

SR NO	SYMBOL	DESCRIPTION	SR NO	SYMBOL	DESCRIPTION
38		STORAGE WATER HEATER	46		SWITCH WITH PILOT LAMP
39		BELL	47		SWITCH, two pole
40		EARTH, GROUND	48		EARTH POINT





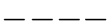













**E- Wiring and Distribution**

SR NO	SYMBOL	DESCRIPTION	SR NO	SYMBOL	DESCRIPTION
1		GENERAL WIRING	7		WIRING GOING DOWNWARDS
2		WIRING ON SURFACE	8		WIRING GOING THROUGH
3		WIRING UNDER SURFACE	9		CIRCUIT MAIN
4		WIRING IN CONDUIT ON SURFACE	10		DISTRIBUTION BOARD
5		WIRING IN CONDUIT UNDER SURFACE (CONCEALED)	11		SUB-DISTRIBUTION BOARD
6		WIRING GOING UPWARDS	12		MAIN PANEL

**F- Lightning Protection Apparatus****G- Fire Alarm Apparatus**

SR NO	SYMBOL	DESCRIPTION	SR NO	SYMBOL	DESCRIPTION
1		LIGHTNING FINAL	1		SMOKE DETECTOR
2		TEST TERMINAL BOX	2		HEAT DETECTOR
			3		MANUAL OPERATED FIRE ALARM
3		EARTH FOR LIGHTNING SYSTEM	4		AUTOMATIC FIRE DETECTOR SWITCH
			5		FIRE ALARM BELL
4		CONDUCTOR	6		FIRE ALARM INDICATOR

**H- Wiring Accessories**

SR NO	SYMBOL	DESCRIPTION	SR NO	SYMBOL	DESCRIPTION
1		SINGLE POLE SWITCH	10		5-10A SOCKET OUTLET
2		DOUBLE POLE SWITCH	11		5-10A SWITCHED SOCKET OUTLET
3		PULL-CORD SWITCH	12		13A SOCKET OUTLET
4		2 WAY SWITCH	13		13A SWITCHED SOCKET OUTLET
5		INTERMEDIATE SWITCH	14		15A SOCKET OUTLET
6		DIMMER SWITCH	15		15A SWITCHED SOCKET OUTLET
7		TIME SWITCH	16		5-10A INTERLOCKING SWITCHED SOCKET OUTLET
8		PUSH BUTTON	17		13A INTERLOCKING SWITCHED SOCKET OUTLET
9		BELL	18		15A INTERLOCKING SWITCHED SOCKET OUTLET

## ANNEX B

[Clause 5B.4.2.4(b)]

**AREA REQUIRED FOR TRANSFORMER ROOM AND SUBSTATION FOR DIFFERENT CAPACITIES**

**B-1** The requirement for area for transformer room and substation for different capacities of transformers is given below for guidance:

Sl No	Capacity of Transformer(s) KVA	Total Transformer Room Area Minimum,m <sup>2</sup>	Total Substation Area ( In Coming, HV,MV Panels, Transformer Roof Without Generators),Minimum	Suggested Minimum Width m	Face
i)	1 x 160	14.0	90	9.0	
ii)	2 x 160	28.0	118	13.5	
iii)	1 x 250	15.0	91	9.0	
iv)	2 x 250	30.0	121	13.5	
v)	1 x 400	16.5	93	9.0	
vi)	2 x 400	33.0	125	13.5	
vii)	3 x 400	49.5	167	18.0	
viii)	2 x 500	36.0	130	14.5	
ix)	3 x 500	54.0	172	19.0	
x)	2 x 630	36.0	132	14.5	
xi)	3 x 630	54.0	176	19.0	
xii)	2 x 800	39.0	135	14.5	
xiii)	3 x 800	58.0	181	14.0	
xiv)	2 x 1000	39.0	149	14.5	
xv)	3 x 1000	58.0	197	19.0	

## NOTES

- 1 The above dimensions are overall area required for substation excluding generating set.
- 2 The clear height required for substation equipment shall be minimum of 3.0 m below the soffit of the beam.



## ANNEX C

*[Clause 5B.4.2.4(j)]***ADDITIONAL AREA REQUIRED FOR GENERATOR IN ELECTRIC SUBSTATION**

**C-I** The requirement of additional area for generator in electric substation for different capacities of generators is given below for guidance:

Sr. No	Capacity KW	Area m <sup>2</sup>	Clear Height below the soffit of the Beam m
(1)	(2)	(3)	(4)
i)	25	56	3.6
ii)	48	56	3.6
iii)	100	65	3.6
iv)	150	72	4.6
v)	248	100	4.6
vi)	350	100	4.6
vii)	480	100	4.6
viii)	600	110	4.6
ix)	800	120	4.6
x)	1000	120	4.6
xi)	1250	120	4.6
xii)	1600	150	4.6

NOTE — The area and height required for generating set room given in the above table are for general guidance only and may be finally fixed according to actual requirements.

## ANNEX D

## FORM OF COMPLETION CERTIFICATE

I/We certify that the installation detailed below has been installed by me/us and tested and that to the best of my/our knowledge and belief, it complies with *MYANMAR Electricity Rules*,

Electrical Installation at -----

Voltage and system of supply

Particulars of Works:

a) Internal Electrical Installation

No.	Total Load	Type of system of wiring
i) Light point		
ii) Fan point		
iii) Plug point		
3-pin 6 A		
3-pin 16 A		

b) Others

Description	hp/kW	Type of starting
1) Motors:		
i)		
ii)		
iii)		
2) Other plants:		

1) Motors:

- i)
- ii)
- iii)

2) Other plants:

c) If the work involves installations of over head line and/or underground cable

- 1) i) Type and description of over headline.
- ii) Total length and number of spans.
- iii) No. of street lights and its description.
- 2) i) Total length of underground cable and its size:
- ii) No. of joints:
  - End joint:
  - Tee joint:
  - Straight through joint:

Earthing:

- i) Description of earthing electrode
- ii) No. of earth electrodes
- ii) Size of main earth lead

Test Results:

a) Insulation Resistance

- i) Insulation resistance of the whole system of conductors to earth Megaohms.
- ii) Insulation resistance between the phase conductor and neutral
 

Between phase R and neutral	.....	Megaohms.
Between phase Y and neutral	.....	Megaohms.
Between phase B and neutral	.....	Megaohms.
- iii) Insulation resistance between the phase conductors in case of polyphase supply.
 

Between phase R and phase Y	.....	Megaohms
Between phase Y and phase B	.....	Megaohms
Between phase B and phase R	.....	Megaohms

- b) Polarity test:  
Polarity of non-linked single pole branch switches
- c) Earth continuity test:  
Maximum resistance between any point in the earth continuity conductor including metal conduits and main earthing lead Ohms.
- d) Earth electrode resistance:  
Resistance of each earth electrode.
  - i) ..... Ohms.
  - ii) ..... Ohms.
  - iii) ..... Ohms.
  - iv) ..... Ohms.
- e) Lightning protective system.  
Resistance of the whole of lightning protective system to earth before any bonding is effected with earth electrode and metal in/on the structure ..... Ohms.

Signature of Supervisor

Name and Address

.....  
.....  
.....  
.....

Signature of Contractor

Name and Address

.....  
.....  
.....  
.....

## LIST OF STANDARD

The following list records those standards which are acceptable standards 'in the fulfillment of the requirements of the Code. The latest version of a standard shall be adopted at the time of the enforcement of the Code. The standards listed may be used by the Authority as a guide in conformance with the requirements of the referred clauses in the Code.

- (i) Myanmar Electricity Rules.
- (ii) Indian Electricity Rules 1956

<i>IS No.</i>	<i>Title</i>
(1) 8270 (Part 1):1976	Guide for preparation of diagrams ,charts and tables for electro technology: Part1 Definitions and classification
1885 (Part 16/ Sec3) 1967	Electro technical vocabulary: Lighting, Section 3 Lamps and auxiliary apparatus
(Part 17):1979	Switchgear and control gear ( first revision)
(Part 32):1993	Electrical cables ( First Revision)
(Part 78):1993	Generation , transmission and distribution of electricity General
12032 (Part 6):1987	Graphical symbols for diagrams in the field of electro technology: Protection and conversion of electrical energy
(Part 7):1987	Switchgear, control gear and protective devices
(2) 7752 (Part 1):1975	Guide for improvement of power factor in consumer installation: Part 1 Low and medium supply voltages
(3) 5216 (Part 1):1982	Recommendations on safety procedures and practices in electrical work: General ( first revision)
(Part 2):1982	Life saving techniques (first revision)
(4) 10118 (Part 2):1982	Code of practice for selection, installation and maintenance of switchgear and control gear: Part 2 Selection.
(5) 1646:1997	Code of practice for fire safety of buildings ( general):Electrical

## ELECTRICAL AND ALLIED INSTALLATIONS

	installations (second revision)
(6) 732:1989	Code of practice for electrical wiring installation ( third revision)
1255:1983	Code of practice for installation and maintenance of power cables ( up to and including 33kV rating)( second revision )
(7) 13947:1993	Specification for low-voltage switchgear and control gear
(8) 2148:1981	Specification for flame-proof enclosures of electrical apparatus ( second revision)
(9) 5578:1985	Guide for marking of insulated conductors ( first revision)
(10) 1777:1978	Industrial luminaire with metal reflectors (first revision)
2206	Flameproof electric lighting fittings:
(part 1):1984	Well –glass and bulkhead types ( first revision)
(Part 2):1976	Fittings using glass tubes
3287:1965	Industrial lighting fittings with plastic reflectors
3528:1966	Waterproof electric lighting fittings
3553:1966	Specification for watertight electric lighting fittings
4012:1967	Specification for dust-proof electric lighting fittings
4013:1967	Dust-tight electric lighting fittings
<i>IS No.</i>	<i>Title</i>
5077:1969	Decorative lighting outfits
10322( Part 5/ Sec 5): 1987	Luminaries: Part 5 Particular requirements , Section 5 Flood lights
(11) 8828:1996	Electrical accessories – Circuit – breakers for over current protection for household and similar installations ( second revision)
13947	Specification for low –voltage switchgear and control gear:
(Part 1):1993	General rules
(Part 2):1993	Circuit –breakers
(Part 3):1993	Switches , disconnectors, switch disconnectors and fuse combination units

## ELECTRICAL AND ALLIED INSTALLATIONS

(Part4/Sec1) :1993	Contactors and motor –starters, section 1 Electro-technical contactors and motor starters
(Part5/Sec1) :1993	Control circuit devices and switching elements , section 1 Electro-technical control circuit devices
(12) 3961	Recommended current ratings for cables:
(Part 1):1967	Paper insulated lead sheathed cables
(Part 2):1967	PVC insulated and PVC sheathed heavy duty cables
(Part 3):1968	Rubber insulated cables
(Part 5):1968	PVC insulated light duty cables
(13) 2086:1993	Specification for carriers and bases used in rewirable type electric fuses for voltages up to 650 V (third revision)
13703 (Part 1):1993	LV fuses for voltages not exceeding 1000 V ac or 1500 dc: Part 1 General requirement
(14) 2672:1966	Code of practice for library lighting
4347:1967	Code of practice for hospital lighting
6665:1972	Code of practice for industrial lighting
8030:1976	Specification for luminaries for hospitals
(15) 732:1989	Code of practice for electrical wiring installations (third revision)
IS No.	Title
(16) 4648:1968	Guide for electrical layout in residential buildings
(17) 900:1992	Code of practice for installation and maintenance of induction motors (second revision)
(18) 2412:1975	Link clips for electrical wiring (first revision)
(19) 2667:1988	Fittings for rigid steel conduits for electrical wiring (first revision)
3419:1989	Fittings for rigid non-metallic conduits (second revision)
9537	Conduits for electrical installations:
(Part 1):1980	General requirements
(Part 2):1981	Rigid steel conduits

## ELECTRICAL AND ALLIED INSTALLATIONS

(Part 3):1983	Rigid plain conduits of insulating materials
14772:2000	Specification for accessories for household and similar fixed electrical installations
(20) 1913 (Part 1):1978	General and safety requirements for luminaires: Part 1 Tubular fluorescent lamps (second revision)
(21) 1258:1987	Bayonet lamp holders (third revision)
(22) 418:1978	Tungsten filament general service electric lamps (third revision)
1534 (Part 1):1977	Ballast for fluorescent lamp:Part1 for switch start circuits (second revision)
<i>SI No.</i>	<i>Title</i>
1569:1976	Capacitors for use in tubular fluorescent high pressure mercury and low pressure sodium vapour discharge lamp circuit ( first revision)
2215:1983	Specification for starters for fluorescent lamps ( third revision)
2418 (Part 1):1977	Specification for tubular fluorescent lamps for general lighting service: Requirements and tests (first revision)
(Part 2):1977	Standard lamp data sheets (first revision)
(Part 3):1977	Dimensions of G-5 and G-13 lc –pin caps ( first revision)
(Part 4):1977	Go and no-go gauges for G-5 and G-13 lc –pin caps ( first revision)
3323:1980	Bi-pin lampholders for tubular fluorescent lamps ( first revision)
3324:1982	Holders for starters for tubular fluorescent lamps ( first revision )
9900 (Part 1):1981	Basic environmental testing procedures for electronic and electrical items: General
(Part 2):1981	Cold test
(Part 3):1981	Dry heat test
(Part 4):1981	Damp test ( steady state )
(23) 374:1979	Electric ceiling type fans and regulators ( third revision)
(24) 3043:1987	Code of practice for earthing

## ELECTRICAL AND ALLIED INSTALLATIONS

- (25) 8623 Specification for low-voltage switchgear and control gear assemblies:Part1Requirements for type-tested and partially type-tested assemblies ( first revision)  
(Part 1):1993
- (26) 10028 Code of practice for selection, installation and maintenance of transformers:  
(Part 2):1981 Part2 Installation
- 11353:1985 Guide for uniform system of marking and identification of conductors and apparatus terminals
- (27) 2309:1989 Code of practice for the protection of buildings and allied structures against lightning (second revision)



References may be made to the following publications for better applying and understanding of the requirements of the Code

- IEC 60079 Electrical apparatus for explosive gas atmospheres
- IEC 60085 Electrical insulation-Thermal classification
- IEC 60127 Miniature fuses
- IEC 60189 Low-frequency cables and wires with PVC insulation and PVC sheath
- IEC 60227 Polyvinyl chloride insulated cables of rated voltages up to and including 450/750V
- IEC 60228 Conductors for insulated cables
- IEC 60238 Edison screw lampholders
- IEC 60245 Rubber insulated cables of rated voltages up to and including 450/750V
- IEC 60269 Low-voltage fuse
- IEC 60309 Plugs, socket-outlets and couplers for industrial purposes
- IEC 60364 Low-voltage electrical installations /Electrical installation of building
- IEC 60423 Conduit systems for cable management-Outside diameters of conduits for electrical installation and threads for conduits and fittings
- IEC 60439 Low-voltage switchgear and control gear assemblies
- IEC 60529 Degree of protection provided by enclosures (IP Code)
- IEC 60617 Graphical symbols for diagrams
- IEC 60669 Switches for household and similar fixed electrical installations
- IEC 60702 Mineral insulated cables and their terminations with a rated voltage not exceeding 750V
- IEC 60755 General requirements for residual current operated protective devices
- IEC 60898 Electrical accessories-Circuit-breakers for overcurrent protection for household and similar installations
- IEC 60947 Low-voltage switchgear and control gear
- IEC 60950 Information technology equipment-Safety
- IEC 61008 Residual current operated circuit-breakers without integral overcurrent

## ELECTRICAL AND ALLIED INSTALLATIONS

protection for household and similar uses (RCCBs)

IEC	61009	Residual current operated circuit-breakers with integral overcurrent protection for household and similar uses (RCBOs)
IEC	61084	Cable trunking and ducting systems for electrical installations
IEC	61140	Protection against electric shock-Common aspects for installation and equipment
IEC	61386	Conduit system for cable management
IEC	61643	Low-voltage surge protective devices
IEC	62305	Protection against lightning
IEE	519	IEEE recommended practices and requirement for harmonic control in electrical power system.
BS EN	50266	Common test method for cables under fire conditions- Test for vertical flame spread of vertically- mounted bunched wires or cables
BS EN	50310	Application of equipotential bonding and earthing in buildings with information technology equipment
BS EN	60332-1-2	Tests on electric and optical fibre cables under fire conditions-Test for vertical flame propagation for a single insulated wire or cable-Procedure for 1 KW pre-mixed flame
BS EN	60598	Luminaires
BS EN	61034-2	Measurement of smoke density of cables burning under defined conditions-Test procedure and requirements
BS EN	61534	Power track systems
BS EN	61558	Safety of power transformers, power supply ,supplies, reactors and similar products
BS EN	61558-2-5	Safety of power transformers, power supply units and similar-Particular requirements for shaver transformers and shaver supply units
BS	31	Specification-steel conduit and fittings for electrical wiring
BS	88	Low-voltage fuses/Cartridge fuses for voltages up to and including 1000V a.c and 1500V d.c
BS	88 Part 2	Low-voltage fuses. Supplementary requirements for fuses for use by authorized persons fuses mainly for industrial application).Examples of

standardized systems of fuses AtoI

BS	88 Part 6	Cartridge fuses for voltages up to and including 1000V a.c. and 1500V d.c Specification of supplementary requirements for fuses of compact dimensions for use in 240/415V a.c. industrial and commercial electrical installations.
BS	196	Specification for protected-type non-reversible plugs, socket-outlets, cable-couplers and appliance-couplers with earthing contacts for single-phase a.c. circuits up to 250 volts
BS	476 Part20	Fire tests on building materials and structures. Method for determination of the fire resistance of elements of construction(general principles)
BS	546	Specification-Two-pole and earthing-pin plugs, socket-outlets and socket-outlet adaptors
BS	1361	Specification for cartridge fuses for a.c. circuits in domestic and similar premises
BS	1363	13A plugs, socket-outlets, adaptors and connection units
BS	3036	Specification-Semi-enclosed electric fuses ( ratings up to 100 amperes and 240 volts to earth )
BS	3676	Switches for household and similar fixed electrical installations
BS	4444	Guide to electrical earth monitoring and protective conductor proving
BS	4568	Specification-for steel conduit and fittings with metric threads of ISO form for electrical installations
BS	4607	Non-metallic conduits and fittings for electrical installations
BS	4662	Boxes for flush mounting of electrical accessories requirements and test methods and dimensions
BS	5266	Emergency lighting
BS	5839	Fire detection and fire alarm systems for buildings
BS	6004	Electric cables.PVC insulated, non-armoured cables for voltages up to and including 450/750V, for electric power, lighting and internal wiring
BS	6007	Electric cables. Single core unsheathed heat resisting cables for voltage

## ELECTRICAL AND ALLIED INSTALLATIONS

up to and including 450/750 V for internal wiring

BS	6231	Electrical cables. Single core PVC insulated flexible cables for rated voltage 600/1000 V for switchgear and control gear wiring
BS	6346	Electric cables.PVC insulated, armoured cables for voltage of 600/1000Vand 1900/3300V
BS	6387	Specification for performance requirements for cables required to maintain circuit integrity under fire conditions
BS	6500	Electric cables, Flexible cords rated up to 300/500V, for use with appliances and equipment intended for domestic, office and similar environments
BS	6701	Telecommunications equipment and telecommunications cabling. Specification for installation, operation and maintenance
BS	6724	Electric cables, Thermosetting insulated, armoured cables for voltages of 600/1000 V and 1900/3300V, having low emission of smoke and corrosive gases when affected by fire
BS	7211	Electric cables. Thermosetting insulated, nonarmoured cables for voltages up to and including 450/750V, for electric power, lighting and internal wiring , and having low emission of smoke and corrosive gases when affected by fire
BS	7629	Specification for 300/500V fire resistant electric cables having low emission of smoke and corrosive gases when affected by fire
BS	7671	Requirements for electrical installations. IEE Wiring Regulations. Seventeenth Edition
BS	7919	Electric cable .Flexible cables rated up to 450/750V, for use with appliances and equipment intended for industrial and similar environments.
AS/NZS	1768	Lightning protection
NFPA	780	Standard for the installation of lightning protection systems

References may be made to the following publications for the common personal protective equipment and tools used for electrical work.

BS EN	60900	Live working –Hand tools for use up to 1000Va.c.and 1500 V d.c
BS EN	60903	Live working-Gloves of insulating material
BS IEC	ISO 20345	Personal protective equipment-Safety footwear
BS IEC	61111	Matting of insulating material for electrical purposes
BS EN	61112	Blankets of insulating material for electrical purposes
ASTM	F1506	Standard performance specification for flame resistant textile materials for wearing apparel for use by electrical workers exposed to momentary electric arc and related thermal hazards

#### References

International Energy Conservation Code 2009

International Green Construction Code 2010